

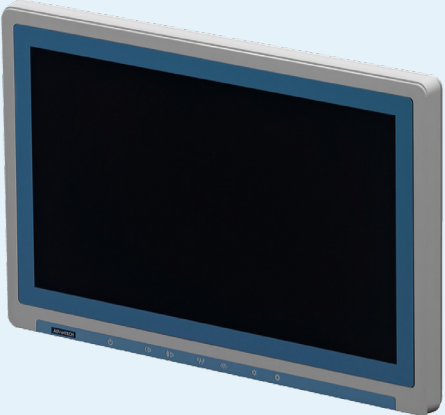





Advantech Ordering Guide Reference Chart

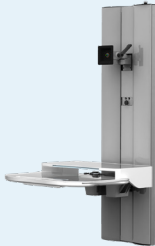

Device	Mounting Kit	Mounting Platform	Restrictions	Add-ons
 <p>Advantech POC-W213 15.2 lbs (6.9 kg)*</p>	N/A	 <p>AHM-FITW-D05-60-M</p>	N/A	 <p>Power Supply</p>
		 <p>AHC-1-L4-D4-C0</p>	N/A	
		 <p>AHM-LCD-05</p>	N/A	

Advantech Ordering Guide Reference Chart



Device	Mounting Kit	Mounting Platform	Restrictions	Add-ons
 <p>Power Supply 1.5 lbs (0.9 kg)*</p>	<p>N/A</p>	 <p>PWRHLD-MON</p>	<p>Mounts on MRS rail with AHM/AHC</p>	<p>N/A</p>

*Weight provided to help approximate mounting capacity. For reference only.