

# LCD Mounting

## PM5 Patient Monitor 5" Shelf

with **VESA** Plate for LCD



**INCLUDES:**

- 4 x M4 10 mm screws
- 4 x M4 14 mm screws
- 8 x 10/32" screws
- 4 x 20 mm zinc-plated screws
- 4 x nylon standoffs

### Technical Drawings

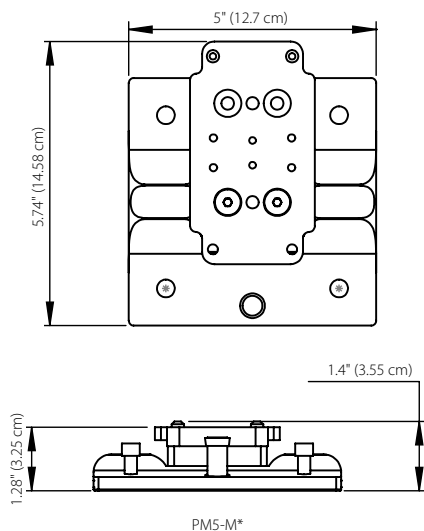

**MODEL MAXIMUM DEPTH**

Back of adapter to front of plate (back of monitor) distance.

V = 3.16" (8.03 cm)	A = 2.92" (7.42 cm)	PLH = 3.18" (8.07 cm)
D = 3.25" (8.23 cm)	E25 = 2.15" (5.46 cm)	PLV = 3.19" (8.10 cm)
F = 3.25" (8.23 cm)	G = 3.35" (8.51 cm)	R200 = 3.40" (8.64 cm)
*M = 1.28" (3.25 cm)	S = 3.75" (9.53 cm)	

### Features

- Secure locking plunger for quick release
- 75/100 VESA mounting options with easy installation slots
- Compatible with a variety of rail types

### Specifications

- Maximum load of 20 lbs (9.1 kg)
- 5.00" L x 5.74" H

### Mounting Options

- A** Amico Horizontal Rail Mount (compatible with Amico and Modular)
- V** Amico Vertical Rail Mount (compatible with Amico and Modular)
- F** Fairfield Rail Mount (push button optional)
- E** DIN 25 mm (1") Rail Mount (30mm [1.2"], 35 mm [1.4"] optional)
- M** Monitor Rail Mount
- D** Dovetail Rail Mount (compatible with Ohmeda Rail)
- G** Hill-Rom Vertical Rail Mount
- S** HSI Vertical Rail Mount
- DW** Direct Wall Mount
- PLH** Horizontal Pole Clamp (adjustable)
- PLV** Vertical Pole Clamp (adjustable)
- R200** 2" Diameter Pole Clamp

*Amico Accessories includes all the adapters required for the above rail systems*

# Patient Monitor Mounting Accessories

## Power Bar



- Hospital grade, 4 power outlets
- 120 VAC, 60Hz

Part Number: PWRBAR4-MON

## Power Holder



- Holds most power adapters for PCs, patient monitors, and LCDs

Part Number: PWRHLD-MON

## Cord Wrap



- Ideal for managing wires and cords

Part Number: CORDWRAP

## LCD Handle



- Ergonomic handles can be added to any Amico LCD mount
- Knuckle guard protects walls and user's hands
- Weight: 4.3 lbs (1.9 kg)

Part Number: MON-LCD-HANDLE

## Monitor Channel



- Standard wall channel 34" (86.3 cm)
- Seismic options are available and custom lengths are welcome

Part Number: MRS-S034

## Channel Covers



- Easy way to hide wires
- Available in patterns and colors to match any decor

Call for part number.

## Wire Baskets

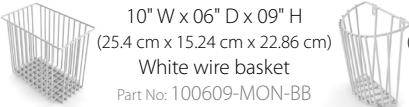

<p>10" W x 06" D x 09" H (25.4 cm x 15.24 cm x 22.86 cm) White wire basket Part No: 100609-MON-BB</p>	<p>13" W x 09" D x 07" H (33.02 cm x 22.86 cm x 17.78 cm) BP cuff basket Part No: CUFBASK-MON</p>
---	---



All baskets can be sterilized

## Printer Mounts



- Mounts most portable printers to conveniently print at the bedside

## CPU Mounts

<ul style="list-style-type: none"> <li>• Available Sizes:</li> <li>1.5" - 3" (3.81 cm - 7.62 cm) Part No: CPUMNT1-MON</li> <li>1.5" - 7" (3.81 cm - 17.78 cm) Part No: CPUMNTA-MON</li> <li>7" - 9.5" (17.78 cm - 24.13 cm) Part No: CPUMNT4-MON</li> </ul>	 <ul style="list-style-type: none"> <li>• Thin client mount behind LCD</li> <li>10" x 10" x 1.75" (25.4 cm x 25.4 cm x 4.45 cm)</li> <li>10" x 10" x 3" (25.4 cm x 25.4 cm x 7.62 cm)</li> </ul>	 <ul style="list-style-type: none"> <li>• Enclosed CPU Mount</li> </ul>	 <ul style="list-style-type: none"> <li>• Tangent Rugged Mini mount</li> </ul>
---	---	---	---

NOTE: All dimensions are not exact.

Please visit [www.amico.com](http://www.amico.com) for all technical specifications, installation instructions, detailed AutoCAD drawings, and more Mounting Solutions.

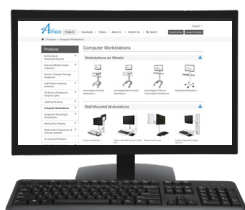

## Distributed By:

