

Approval and Installation Booklet

Rigid-LITE (Stationary) Ceiling Column



Order #: _____

Project Name: _____

Model Number: _____

Quantity: _____

Address: _____



The Amico Group Manufactures the Building Blocks of the Hospital



One Point of Contact
One Total Solution

Amico Corporation has been a leading manufacturer of Medical Equipment since 1974, selling its products through a global distribution channel from six manufacturing facilities in Canada and the U.S.

With a track record of exceeding expectations, Amico is dedicated to developing and manufacturing the most advanced medical equipment for the industrial and global Health Care Industry. With a wide variety of products for the medical environment, the Amico Group of Companies offer a total hospital solution.

Table of Contents

Product Description	1
Cleaning	1
Inspection and Testing	1
Elevation View	2
Device and Accessory Chart	3
Device Placement (Bottom View)	4
Electrical Diagram (Bottom View)	5
Mounting Plate to Outlet Detail	6
Mounting Information	7
Typical Location View	8

Product Description

The Rigid-LITE Ceiling Column shall be an Amico Alert-1 series. The shroud is made of 16 gauge stainless steel alloy #304 with a # 4 satin finish, consisting of a removable access panel, stainless steel ceiling collar and a heavy gauge steel mounting plate.

All electrical services are provided by means of EMT metal conduits and gas services are type L, oxygen cleaned copper pipes.

NOTE: Nitrogen is type K oxygen cleaned copper pipe.

Standard dimensions are 14 3/4" x 14 3/4" (374.65 mm x 374.65 mm)

NOTE: Electrical devices are pre-wired to electrical junction box at the mounting plate, unless other wise stated. Gases will be manifolded for single point connections to the source. All pipes will extend 8" from the top of mounting plate.

Cleaning

The Amico Outlets are factory cleaned for oxygen service. Exposed surfaces of the outlet may be cleaned with a mild detergent solution or wiped with a disinfectant commonly used in patient rooms that is compatible with plastics, anodized aluminium and die cast zinc.

Inspection and Testing

Medical Gas Outlets should be inspected periodically or at least once a year. The test should be in accordance with NFPA 99 "*Gas and Vacuum systems*", or CSA Z7396.1 "*Nonflammable Medical Gas Piping System*".

Test for Leaks: Ensure that no leaks exist, with or without the adapter inserted.

Test for Indexing: Only a mating gas specific adapter should insert smoothly into the outlet, latch and be retained.

Test for Flow:

- Gas Outlets: 120 l/min (4.2 scfm) @ 345 kPa (50 psi), maximum allowable pressure drop is 28 kPa (4 psi).
- Nitrogen Outlet: 400 l/min (14.1 scfm) @ 1,250 kPa (180 psi), maximum allowable pressure drop is 70 kPa (10 psi).
- Vacuum Outlet: 30 l/min (1.1 scfm) @ 54 kPa (16 inHg), maximum allowable pressure drop is 13 kPa (4 inHg).

Refer to the appropriate standards for the proper way of performing the flow test.

NOTE: Amico medical gas and vacuum outlets meet and exceed these requirements at the time of manufacture. However, piping source capacity, sizing and restrictions may prevent outlets from attaining these values.

Elevation View

To accommodate different ceiling heights, Amico Corporation has standardized three different variations.

Please select the required nominal column height below:

L1= Nominal Column Height

30" (762mm)

36" (914.4mm)

42" (1066.8mm)

Ceiling Height:

Column Height

Floor Clearance:

Quantity

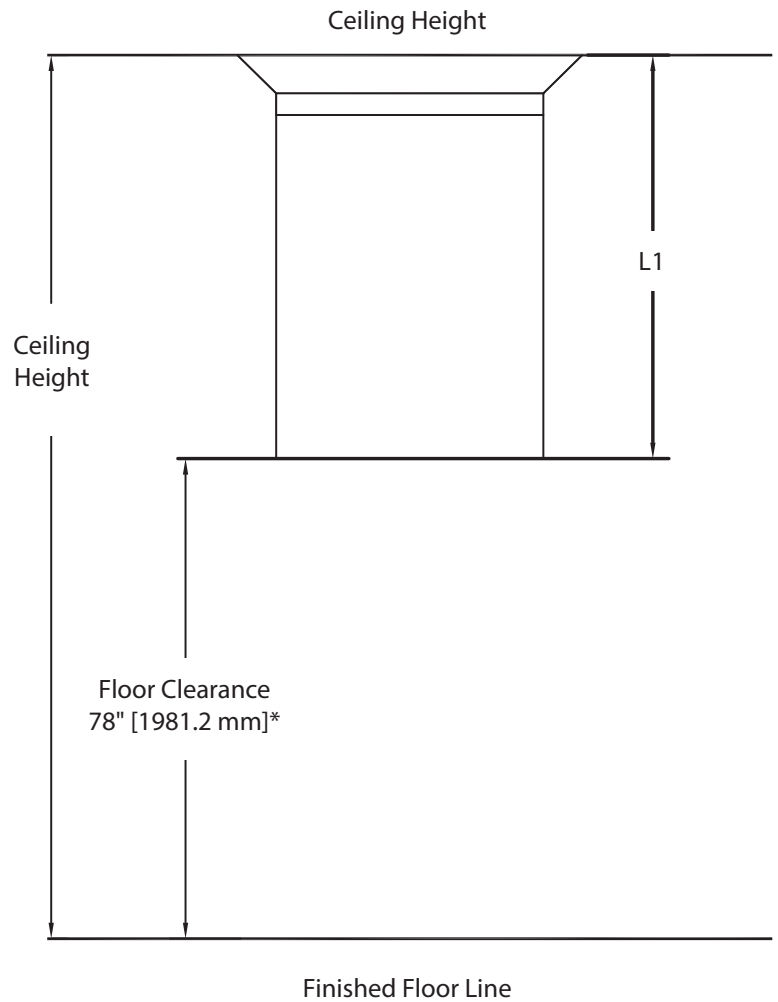

* Recommended Floor Clearance







NOTE: Custom heights are available at an additional cost. Please contact Amico for pricing.

Approval Signature

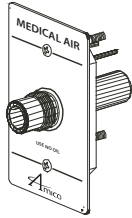
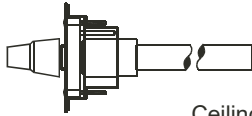
Date

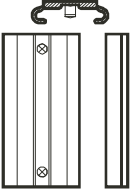
Phone No.

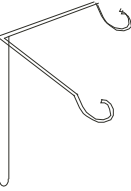
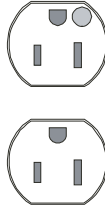
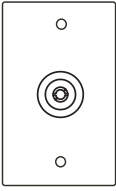
Device and Accessory Chart

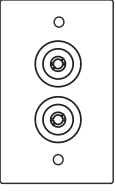
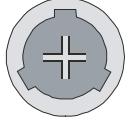
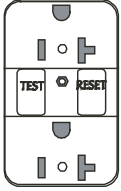
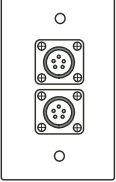
 <p>*DI XXX</p> <p>DISS</p>	 <p>PE</p> <p>Ceiling Column Passive Evacuation (19 mm/33 mm)</p>	 <p>E9-RED E10-IVORY</p> <p>Duplex Receptacle 125V/20a (US/International)</p>
<p>Quick Connect Style Latch Valves available upon request (Check local code first)</p>	 <p>SL</p> <p>Vacuum Bottle Slide</p>	 <p>E11-RED E12-IVORY</p> <p>Single Receptacle 125V/20a (US/International)</p>
<p>Quick Connect Style Latch Valve Requested:</p>	 <p>IV</p> <p>Stainless Steel IV Hook (Duplex only)</p>	 <p>E5-RED E6-IVORY</p> <p>Duplex Receptacle 125V/15a (CAN/International)</p>
 <p>GJ</p> <p>Ground Jack Receptacle Single Bender (SLR-3) GREEN</p>	<p>DJ DP</p> <p>DJ: Data-Telephone Communication Jack or Duplex Receptacle (Provision Only)</p> <p>DP: Duplex Receptacle Provision</p>	 <p>E7-RED E8-IVORY</p> <p>Single Receptacle 125V/15a (CAN/International)</p>
 <p>GJ2</p> <p>Ground Jack Receptacle Dual Bender (SLR-3) GREEN</p>	 <p>TL</p> <p>Twist-Lock Receptacle Hubble 23000-HG 125V/20a</p>	 <p>E13C-RED E13-RED E14C-IVORY E14-IVORY</p> <p>Ground Fault Circuit Interrupter (C = Canadian)</p>
 <p>MJ</p> <p>Monitor Jack Duplex (5-pin shown) Amphenol Model 10-825806-05S 97-14S-5S</p>	<p>All electrical devices are Hospital Grade.</p> <p>i NOTES:</p> <ol style="list-style-type: none"> 1. DISS outlets recommended per NFPA 99 current code. 2. Carbon dioxide outlets are not available in Puritan-Bennett. Nitrogen outlets are only available in DISS. 3. Passive WAGD outlets are available in DISS only. 4. Instrument Air is available in DISS only. 	

Approval Signature

Date

Phone No.

Device Placement (Bottom View)

Please populate the diagram below by indicating the locations of all required services.

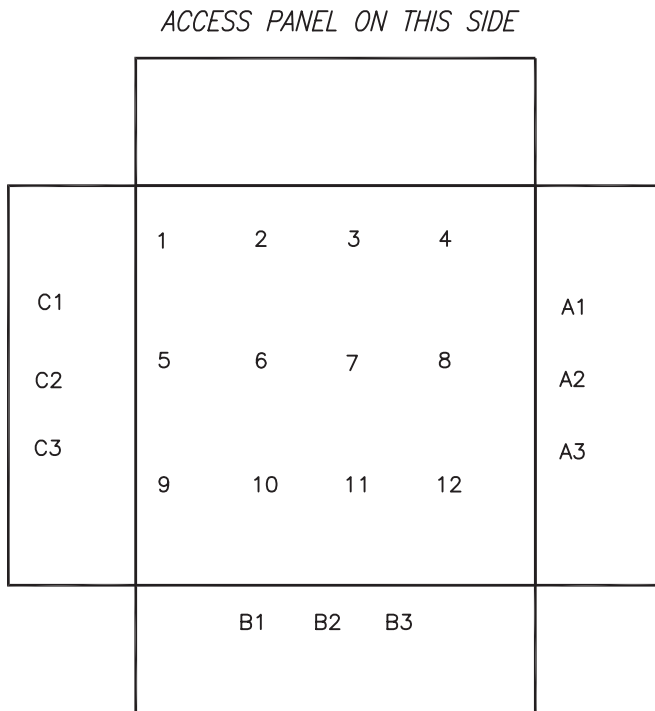

Please Specify Outlet Language

ENGLISH (NFPA)
 ENGLISH (ISO)
 FRENCH
 SPANISH (NFPA)
 SPANISH (ISO)

Gas Legend

Oxygen	= O
Medical Air	= A
Vacuum	= V
Nitrous Oxide	= 2
Nitrogen	= N
Carbon Dioxide	= C
WAGD (NFPA)	= W
AGSS (ISO)	= E
Instrument Air	= I

Positions 1 - 12 = Medical Gas Outlets

Positions A1 - C3 = Electrical and/or communication devices

i NOTES:

1. A maximum of 2 data provisions only.
2. Multiple of a gas outlet can only be placed in groups. Example: OXY (position 1+2 or 1+5).

Approval Signature

Date

Phone No.

Electrical Diagram (Bottom View)

***Please Select One of the Following:**

Amico recommended circuit schedule based on layout
 Custom circuit schedule. Please specify on circuit chart

Receptacle Type:

US/CAN
 *BRITISH (simplex only)
 *GERMAN (simplex only)

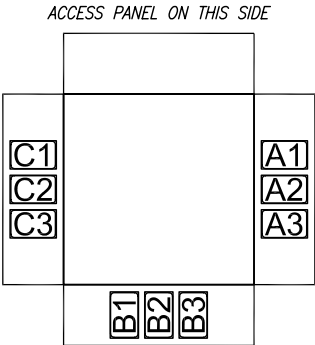

Circuit Chart

CIRCUIT NUMBER	CIRCUIT NUMBER
A1	B1
A2	B2
A3	B3

CIRCUIT NUMBER
C1
C2
C3

***Please Specify Electrical Details:**

Type of Wire:
 THHN XHHW RW90 XLPE

AWG Wire Gauge: **Wire Color:**

10 & 12 LIVE/HOT

10 & 12 NEUTRAL

10 GROUND

Isolated Power

***Please Select One of the Following:**

All receptacles shall be mounted with ground pin "DOWN"

All receptacles shall be mounted with ground pin "UP" (Default)

- i NOTES:**
- If type of wire & gauge is not specified, Amico will use the following:
 - For US/International:**
 - LIVE/HOT - 12 Ga. THHN Wire Black
 - NEUTRAL - 12 Ga. THHN Wire White
 - GROUND - 10 Ga. THHN Wire Green
 - For Canada:**
 - LIVE/HOT - 12 Ga. RW90 Wire Black
 - NEUTRAL - 12 Ga. RW90 Wire White
 - GROUND - 10 Ga. RW90 Wire Green
 - Conduit: 1/2" (12.7mm] rigid EMT.
 (3/4" rigid EMT for low voltage pro)
 - A pull-string will be provided to be connected by others for all ground jacks and data provision.
 - British or German Receptacle cannot be positioned side by side ie: A1 and A2.

 Approval Signature

 Date

 Phone No.

Mounting Plate to Outlet Detail

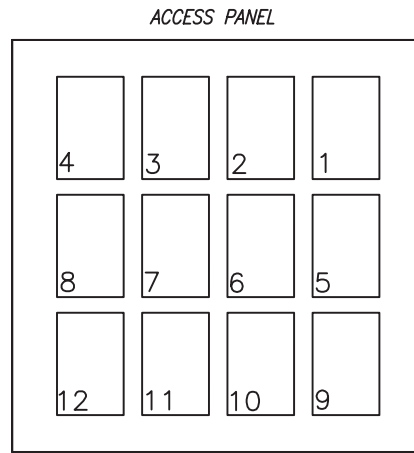
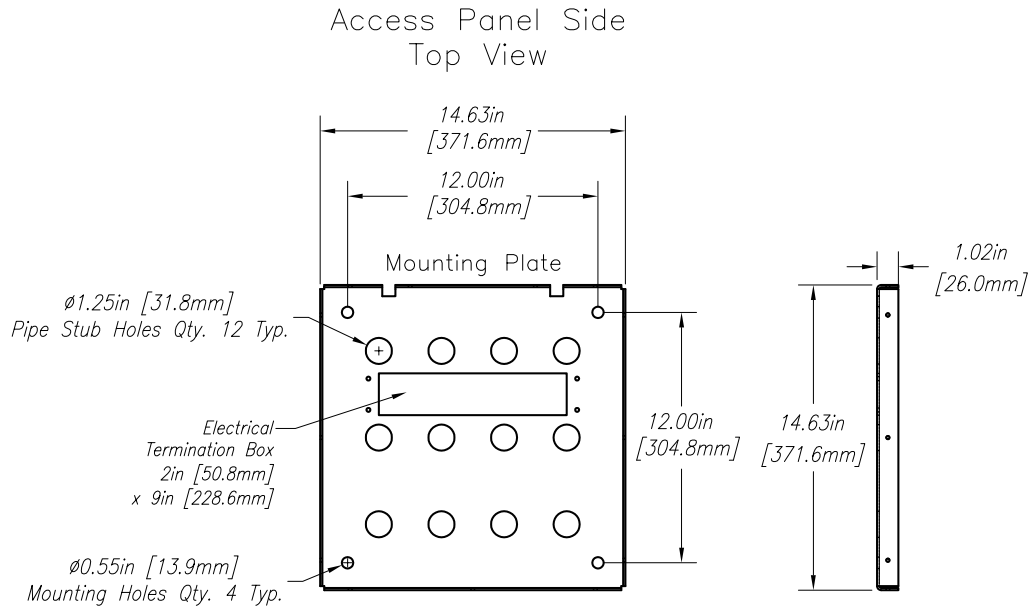

BOTTOM VIEW

***i* NOTES:**

1. Gases will be manifolded for single point connections from source.
2. All pipes will extend 8" from the top of mounting plate.
3. Pipe stubs diameters are:
 - 3/4" dia. for vacuum, WAGD, and AGSS (Type L)
 - 1/2" dia. for medical air, oxygen, and nitrous oxide (Type L)
 - 1/2" dia. for nitrogen (Type K)
4. Exact locations of gas terminations on mounting plate will be determined after receiving the booklet.

 Approval Signature Date Phone No.

Mounting Information

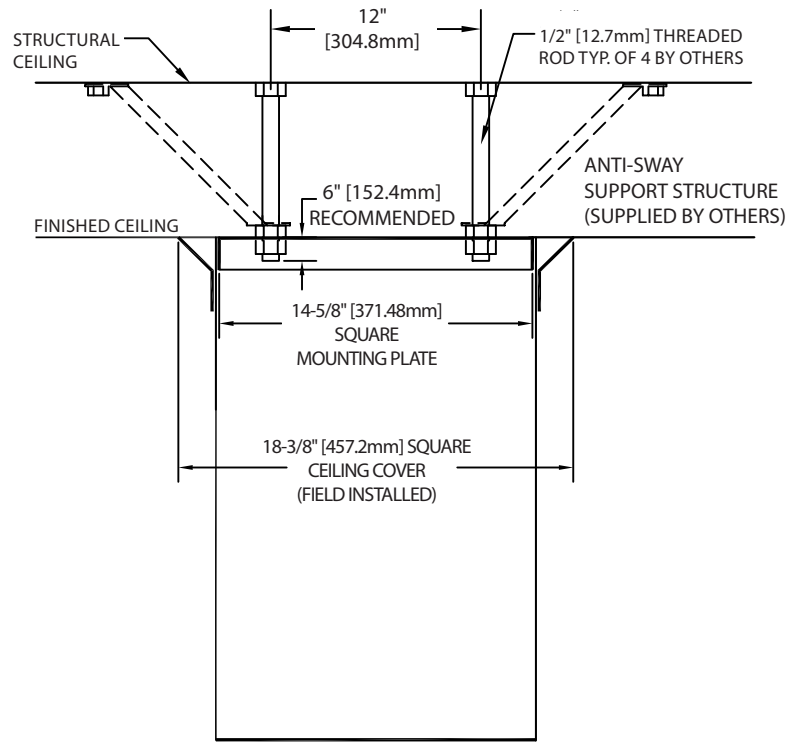

i NOTES:

1. All labour and material for installation of mounting plate to mounting structure supplied by others.
2. Installer has final responsibility for the strength and stability of the mounting structure that is supplied by others.
3. Mounting plate is fixed to the column and cannot be pre-shipped.
4. Mounting plate to be mounted flush with finished ceiling.
5. Gas pipes extend 8" above the column.

Approval Signature

Date

Phone No.

Typical Location View

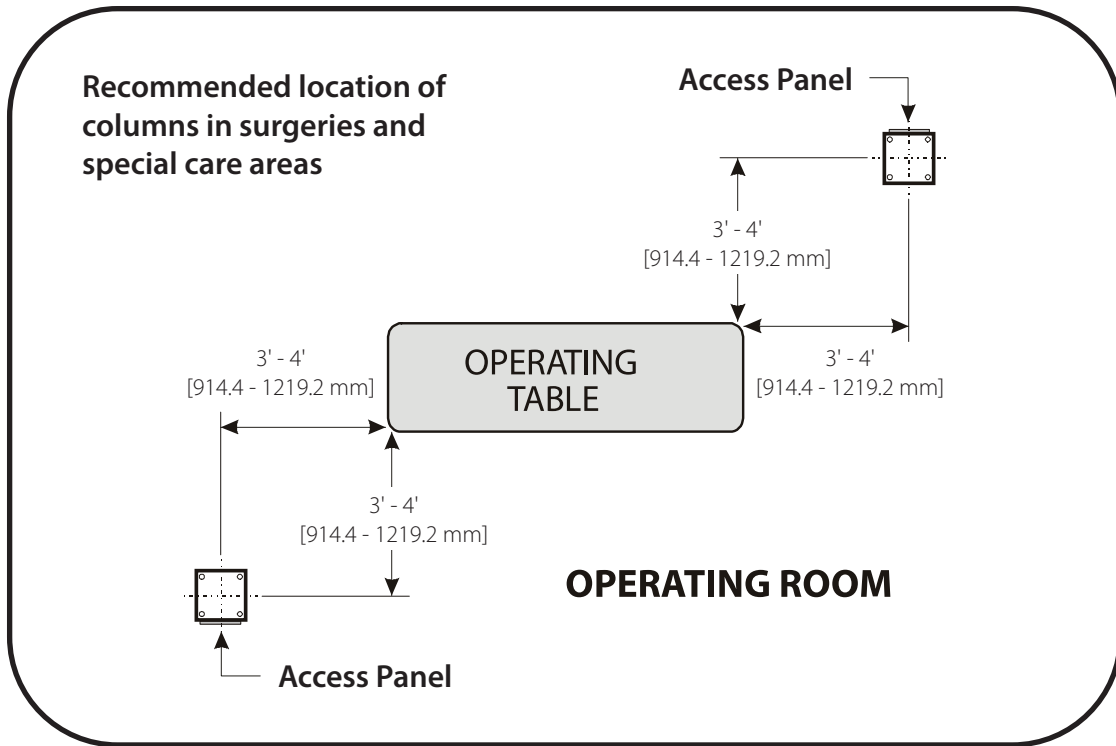

Approval Signature

Date

Phone No.

www.amico.com

Amico Corporation | 85 Fulton Way, Richmond Hill, ON L4B 2N4, Canada
600 Prime Place, Hauppauge, NY 11788, USA
Toll Free Tel: 1.877.462.6426 | Tel: 905.764.0800 | Fax: 905.764.0862
Email: info@amico.com | www.amico.com

