

Operating and Maintenance Manual

Jared Series
Fetal Monitor Carts

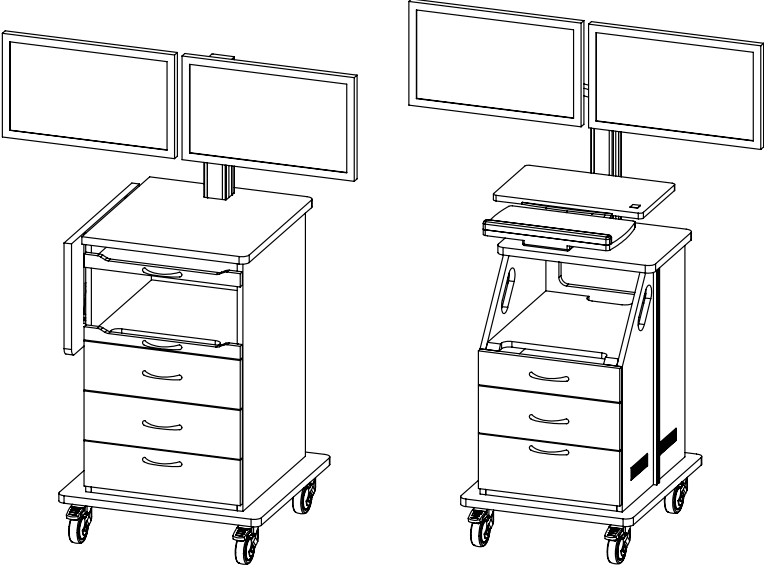

Contents

User Responsibility	1
Receiving Inspection	1
Safety Precautions	2
Intended Use	3
Specifications	3
Fetal Monitor Components	4
Accessory Installation	5
Directions for Proper Use of Fetal Monitor Cart	
Use of Casters	5
Moving the Cart	6
Securing the Cart	6
Use of Keyboard Tray	6
Use of Keyboard Light (Optional)	7
Use of Flip Surface (Optional)	8
Cleaning Instructions	8
Disinfecting Instructions	9
Recommended Maintenance	9
Preventative Maintenance Checklist	9
Warranty Policy	10

User Responsibility

READ ALL INSTRUCTIONS BEFORE USING

This manual is intended to instruct a healthcare professional how to operate and care for the fetal monitor cart as well as to provide important information to allow for proper training of safety to other users of the fetal monitor cart. Only those properly trained on its use should operate this fetal monitor cart.

Using this fetal monitor cart for anything outside of its intended use may result in personal injury or death and/or damage to the equipment.

SYMBOL DEFINITION



WARNING: Indicates a potentially hazardous situation which, if not avoided, could result in death or serious injury.



CAUTION: Indicates a potentially hazardous situation which, if not avoided, may result in minor or moderate injury.



CONSULT ACCOMPANYING DOCUMENTS

Receiving Inspection



Remove the Amico Patient Care Corporation fetal monitor cart from the packaging and inspect it for damage. If there is any sign of damage, **DO NOT USE** and contact your provider.

Safety Precautions

Carefully read and strictly follow the cautions listed on this page. Improper usage of the product could cause injury or death to the patient or operator.



WARNINGS:

- **DO NOT** exceed the safe working load of any component of the cart (drawers, flip surface, keyboard trays, pull out surface, monitor arms, equipment rails and accessories).
- **DO NOT** use any accessories, drawers, keyboard trays, pullout trays or flip surfaces unless the fetal monitor cart has all casters locked and is secure.
- Fetal monitor cart configuration has been tested to verify stability. Fetal monitor cart configurations as specified by Amico Patient Care should not be changed.
- **DO NOT** apply the caster locks to stop the fetal monitor cart while in transport. Caster locks should only be used when fetal monitor cart is intended to be stationary.
- **DO NOT** attempt to move fetal monitor cart when casters are in locked position.
- **DO NOT** move the cart by pushing or pulling the keyboard tray or other accessories or equipment mounts.
- **DO NOT** open more than one drawer at a time.
- When moving cart, all drawers, trays, mounts and equipment should be closed and/or brought inwards to prevent collisions with people, equipment and structures.
- **DO NOT** move the cart at a high rate of speed, use caution while moving.
- Keep both hands on the cart while in motion.
- **DO NOT** open more than one drawer or pull out tray at a time.



CAUTIONS:

- When installing accessories consider their mounting location relative to other equipment, people traffic to prevent hazards due to obstructions.
- **DO NOT** use abrasive cleaners or materials that could damage the surfaces.
- **DO NOT** submerge any part of the fetal monitor cart or allow liquids to pool.

Intended Use

A mobile cart intended to house fetal monitoring equipment and supplies, allowing for monitoring and documentation.

Specifications

Safe Working Loads	
Monitor Arms	8-17 lbs (3.6 – 7.7 kg)
Flip Surface	20 lbs (9 kg)
Keyboard Tray	5 lbs (2.2 kg)
Pull Out Tray	20 lbs (9 kg)
Drawers	10 lbs (4.5 kg)
Equipment Rail	5 lbs (2.2 kg)

	Operating Conditions	Storage Conditions
Temperature	68°F-81°F (20°C-27°C)	55°F-86°F (13°C-30°C)
Relative Humidity	30-60%	30-60%

Fetal Monitor Components

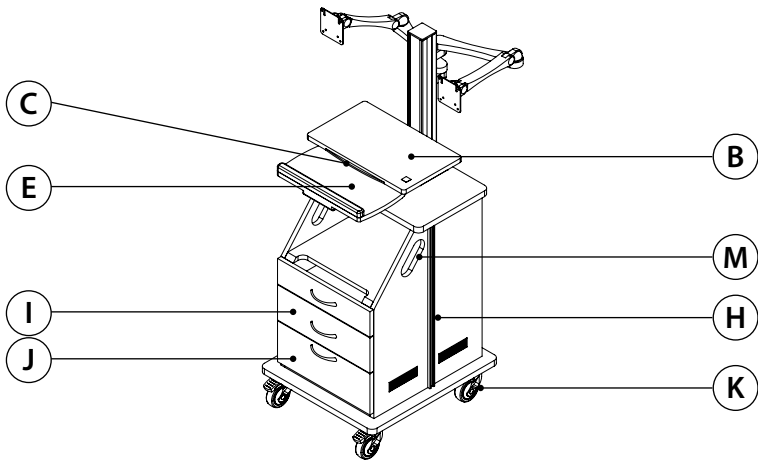
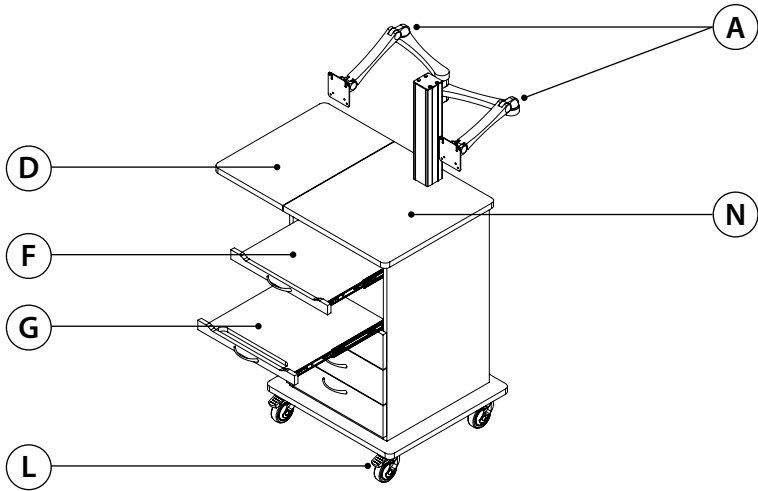

Legend			
A	Monitor Arm	H	Equipment Rail
B	Keyboard Shelf	I	Drawer
C	Keyboard Light	J	Flip Down Compartment
D	Flip Surface	K	Caster
E	Height Adjustable Keyboard Tray	L	Caster Lock
F	Pull Out Keyboard Tray	M	Handle Grip
G	Pull Out Tray	N	Top Surface

Batch Number Location

Product label with batch number can be found on the side panel of the top drawer.

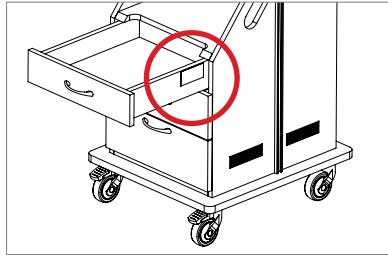

BATCH NUMBER LABEL

Accessory Installation

WARNINGS

- Fetal monitor cart configuration has been tested to verify stability. Fetal monitor cart configurations as specified by Amico Patient Care should not be changed.

CAUTIONS

- When installing accessories consider their mounting location relative to other equipment, people traffic to prevent hazards due to obstructions.

1. Refer to instructions provided with accessories for installation steps.

Directions for Proper Use of Fetal Monitor Cart

USE OF CASTERS:

CAUTIONS

- **DO NOT** apply the caster locks to stop the fetal monitor cart while in transport. Caster locks should only be used when fetal monitor cart is intended to be stationary.
- **DO NOT** attempt to move fetal monitor cart when casters are in locked position.

1. To lock caster, press down on the lever with your foot.
2. To unlock caster, lift up on lever with your foot.

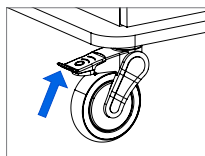

UNLOCKED

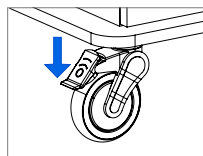

LOCKED

Directions for Proper Use of Fetal Monitor Cart

MOVING THE CART:



WARNINGS

- When moving cart, all drawers, trays, mounts and equipment should be closed and/or brought inwards to prevent collisions with people, equipment and structures.
- **DO NOT** move the cart by pushing or pulling the keyboard tray or other accessories or equipment mounts.
- **DO NOT** move the cart at a high speed, use caution while moving.
- Keep both hands on the cart while in motion.

1. Make sure all drawers and pull out tray are fully closed.
2. Make sure the flip surface is in the down position.
3. Make sure keyboard tray is in fully recessed position.
4. Make sure monitors are not extended outside the work surface of the cart.
5. Make sure all accessories are properly fastened to the cart. Remove any accessories (i.e. baskets) that protrude too far and could interfere with environment.
6. Ensure that the all castors are in unlocked position.
7. With both hands, grip the top surface or handle grips while in motion and take all possible care to make sure path of travel is free from obstruction.

SECURING THE CART:



WARNINGS

- **DO NOT** use any accessories, drawers, keyboard trays, pullout trays or flip surfaces unless the fetal monitor cart has all casters locked and is secure.
- **ONLY** use fetal monitor cart on a flat and level surface.

1. Position the fetal monitor cart on a flat and level surface, in a location that will not obstruct or interfere with equipment or people.
2. Lock all casters are in their locked position.

USE OF KEYBOARD TRAY:



WARNINGS

- **DO NOT** exceed the safe working load of any component of the cart (drawers, flip surface, keyboard trays, pull out surface, monitor arms, equipment rails and accessories).
- **DO NOT** use any accessories, drawers, keyboard trays, pullout trays or flip surfaces unless the fetal monitor cart has all casters locked and is secure.
- **DO NOT** lean on the cart or keyboard tray.

Directions for Proper Use of Fetal Monitor Cart

Height Adjustable Keyboard Tray

1. The height adjustable keyboard tray can be raised and lowered, tilted and able to slide in and out.
2. To lower the keyboard, tilt the tray upwards and lower arm to desired position.

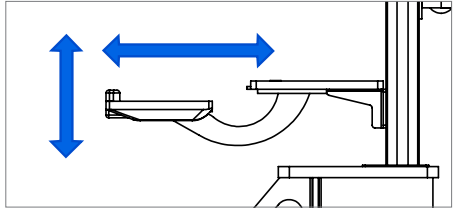
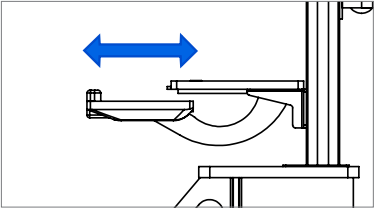

Pull Out Keyboard Tray

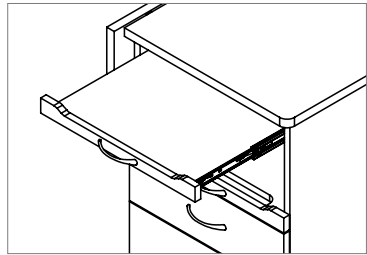
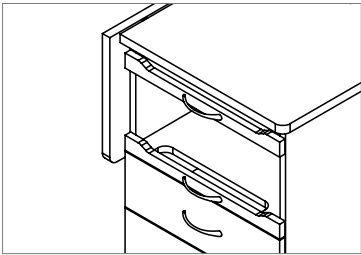

USE OF KEYBOARD LIGHT (OPTIONAL)

1. Make sure USB for the keyboard light is plugged into computer or power supply.
2. Touch marked location on the work surface to turn on or off the keyboard light.

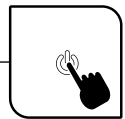
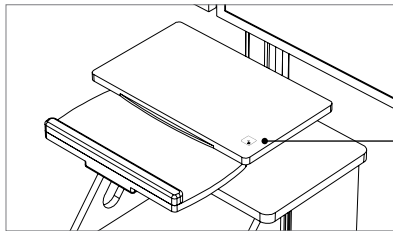

Directions for Proper Use of Fetal Monitor Cart

USE OF FLIP SURFACE (OPTIONAL)

WARNINGS

- **DO NOT** exceed the safe working load of any component of the cart (drawers, flip surface, keyboard trays, pull out surface, monitor arms, equipment rails and accessories).
- **DO NOT** use any accessories, drawers, keyboard trays, pullout trays or flip surfaces unless the fetal monitor cart has all casters locked and is secure.
- **DO NOT** lean on the cart or keyboard tray.

1. Raise flip surface to the horizontal position, allowing it to lock in place.
2. To lower flip surface, press both handles on both support brackets and gently lower to the vertical position.

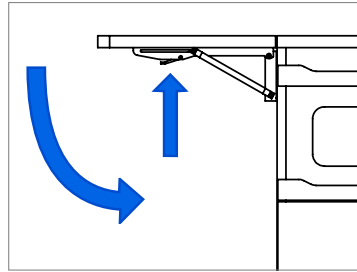
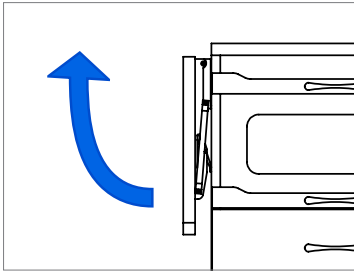

Cleaning Instructions

CAUTIONS

- **DO NOT** submerge any part of the fetal monitor cart or allow liquids to pool.
- **DO NOT** use abrasive cleaners or materials that could damage the surfaces.

1. Lock all casters to secure fetal monitor cart.
2. Apply a mild soap and warm water solution using a low-linting cloth.
3. Wipe dry all surfaces with a low-linting cloth.
4. Ensure all surfaces fully dry before returning to service.

Disinfecting Instructions

CAUTIONS

- **ALWAYS** rinse bassinet using damp cloth with water after cleaning, and dry thoroughly. Some cleaning agents are corrosive by nature, and if not rinsed their residue can cause permanent damage.
- **DO NOT** submerge any part of the fetal monitor cart or allow liquids to pool.
- **DO NOT** use abrasive cleaners or materials that could damage the surfaces.
- **CONSULT** Amico Patient Care for approved cleaning agents for your bassinet.

1. Lock all casters to secure the Fetal Monitor Cart.
2. Apply recommended disinfectant as per disinfectant's instructions. Do not soak the Fetal Monitor Cart.
3. Rinse and wipe dry all surfaces with low-linting cloth to remove any excess liquid and disinfectant.
4. Ensure all surfaces fully dry before returning to service.

Recommended Maintenance

Periodic inspection of this fetal monitor cart is recommended. If any damage or defects are present, the fetal monitor cart should not be used. This includes parts that may have been altered, become contaminated or are worn or missing. If any of the above are noted, immediate repair or replacement is required.

If this device is subject to improper maintenance, repair, use and/or abuse leading to malfunction of the device, replacement is the sole responsibility of the user.

Preventative Maintenance Checklist

Inspect the following items:

- All fasteners are secure
- All accessories are securely fastened
- Work surfaces are intact and secure
- All mechanisms operate freely
- Labels are legible and properly adhered
- All casters are secure and swivel freely
- All four casters glide smoothly and are free of debris
- All locking casters lock and unlock freely
- Drawers are intact and slide freely
- Any wiring is intact with no signs of damage
- Base and Cabinetry free of damage



Warranty Policy - Patient Care Furniture

Amico Patient Care Corporation will warrant its Patient Care Equipment to be free from defects as stated in the warranty period mentioned below. Within this period, Amico Patient Care Corporation will replace any part which is proven to be defective, at no charge. Shipping and Installation costs after the first twelve (12) months will be borne by the Customer.

Amico Patient Care Corporation's warranties are as follows:

- Height Adjustable Overbed Tables, Bassinets (Jordan & Lily Series), Delivery Carts (Ryan Series), and Carts (Sit-to-Stand Series) - 2 years
- Casegoods, Carts, and Bassinets (Marco, Ava & Connor Series) - 5 years
- Seating - Limited Lifetime Warranty

Note: Parts not manufactured by Amico are subject to the manufacturer's warranty. This includes, but is not limited to, all locks and accessories which have been installed on units by Amico.

This warranty is valid only when the product has been properly installed according to Amico Patient Care Corporation specifications, used in a normal manner and serviced according to factory recommendations. It does not cover failures due to damage which occurs in shipments or failures which result from accidents, misuse, abuse, neglect, mishandling, alteration, misapplication or damage that may be attributable to acts of God.

Amico Patient Care Corporation shall not be liable for incidental or consequential damages resulting from the use of the equipment.

All claims for warranty must first be approved by Amico Patient Care Corporation's Customer Service Department at: apc-csr@amico.com or 905.764.0800. Upon approval, the Customer Service Department will issue a Return Goods Authorization (RGA) number. An RGA must be obtained prior to commencement of any warranty claim.

Amico Patient Care Corporation | 122A East Beaver Creek Road, Richmond Hill, ON L4B 1G6, Canada
Toll Free Tel: 1.877.462.6426 | Toll Free Fax: 1.866.440.4986 | Tel: 905.764.0800 | Fax: 905.764.0862
Email: apc-csr@amico.com | www.amico.com