

# Operation and Maintenance Manual

## Reciprocating Air Systems



Model Number: \_\_\_\_\_

Job Number: \_\_\_\_\_

Date Shipped: \_\_\_\_\_

Date Started Up: \_\_\_\_\_

# Introduction

For further technical assistance, service or replacement parts, please contact:

## **Amico Source Corporation**

85 Fulton Way  
Richmond Hill, ON  
L4B 2N4 Canada

Toll Free Tel: 1 877 462 6426

Toll Free Fax: 1866 440 4986

Tel: 905 764 0800

Fax: 905 764 0862

For Technical Support: [as-techsupport@amico.com](mailto:as-techsupport@amico.com)

For Parts: [as-parts@amico.com](mailto:as-parts@amico.com)

Please include the system's job number located on the control panel with all inquires.

Amico Source Corporation reserves the right to make changes and improvements to update products without notice or obligation.

# Table of Contents

Safety Precautions	4
General Information	5
Installation and Commissioning	6-7
Piping	8-10
Wiring	11
Installing the Dew Point Sensor	12
Control Panel	12-21
Reciprocating Air Compressor	22-23
Heatless Desiccant Dryer	24
Dew Point Sensor	25
CO Transmitter	26
Maintenance	26-34
Control Panel Troubleshooting	35-36
Reciprocating Compressor Troubleshooting	37-38
Heatless Desiccant Dryer Troubleshooting	38
Warranty	39-40
Replacement Parts	40
Maintenance Record	41

# Safety Precautions

Pressurized air from the system may cause personnel injury or property damage if the unit is improperly operated or maintained.

Operator should have carefully read and become familiar with the contents of this manual before installing, wiring, starting, operating, adjusting and maintaining the system.

Operator is expected to use common sense safety precautions, good workmanship practices and follow any related local safety precautions.

## **In Addition:**

- Before starting any installation or maintenance procedures, disconnect all power to the package.
- All electrical procedures must be in compliance with all national, state and local codes and requirements.
- A certified electrician should connect all wiring.
- Refer to the electrical wiring diagram provided with the unit before starting any installation or maintenance work.
- Release all pressure from the package before removing, loosening or servicing any covers, guards, fittings, connections or other devices.
- Notify appropriate hospital personnel if repairs or maintenance will affect available compressed air levels.
- Air inlet must be placed in an area free of toxic or hazardous contaminants. It must be kept away from ETO exhaust vents, vacuum exhaust vents, areas close to automotive exhausts, etc. in accordance with NFPA 99.
- Prior to using the Amico Scroll Medical Air System, the medical facility must have a Certifier perform all installation tests as specified in NFPA 99. The medical facility is also responsible for ensuring that the medical air meets the minimum requirements as specified in NFPA 99.
- This is a high speed, rotating piece of machinery. Do not attempt to service any part while the machine is in operation.
- To prevent automatic starting, disconnect all electrical power before performing any maintenance.
- Do not operate unit without belt guards, shields or screens in place.
- Make sure that all loose articles, packing material and tools are clear of the package.
- Check all safety devices periodically for proper operation.
- Never operate a compressor with its isolation (shutoff) valve closed or without its relief valve in place. Damage to the compressor may occur.
- Do not add lubricating oil of any kind to the compressor. Absolutely no oil is required for proper operation.
- The "Hand" mode of operation should only be used for emergencies such as a PLC malfunction and should not be used for normal operation.
- Electrical service must be the same as specified on the control panel nameplate or damage to the equipment may occur.
- Vibration during shipment can loosen electrical terminals, fuse inserts and mechanical connections. Tighten as necessary.

# General Information

## Product Description

The air system is intended for either:

- Medical use for patients
- Pressurizing medical instruments in a medical environment
- Labs

The Amico Scroll Medical Air System is designed according to the specifications agreed upon during the design phase. Changing the intended use is permissible only after prior consultation with Amico Source Corporation.

Suggested operating temperature: 78°F (26°C).

The air system is intended for use indoors unless otherwise specified.

The air system is designed according to local regulations.

## Principles of Operation

The air system takes air from the inlet. The air is passed through an inlet filter to prevent solid matter from entering the air compressor. After compression, the compressed air passes through the aftercooler to reduce the temperature of the air followed by the moisture separator, where moisture is reduced in the air stream. The high pressure air is stored in the receiver until use. When demanded, the air from the receiver travels through an oil coalescing filter (when equipped) and pre-filter. The air is then further dried by a heatless desiccant dryer system to reduce the dew point of the air. Next, the air passes through an after filter, an activated carbon filter (when equipped) and a sterile filter (when equipped). The air is then regulated down to the demanded pressure before delivery to the facility.

All parts of the system are designed to be isolated including the pump(s), tank(s) and dryer(s). This ensures the continuity of medical air for the patients connected to the system.

## Transport

The system is split and crated according to specifications. Amico will make every attempt to split the system into as few pieces as possible to consolidate shipping.

# Installation and Commissioning

## Inspection Upon Receipt

The condition of the Amico Medical Air System should be carefully inspected upon delivery. Any indication of damage by the carrier should be noted on the delivery receipt, especially if the system will not be immediately uncrated and installed.

Amico Source Corporation modules may remain in their shipping containers until ready to be installed. If any of the modules are to be stored prior to installation, they must be protected from the elements to prevent rust and deterioration.

DO NOT REMOVE the protective covers from the inlet and discharge connection ports of the modules until they are ready for connecting to the facility's pipeline distribution system.

## Handling



**WARNING:** USE APPROPRIATE LOAD RATED LIFTING EQUIPMENT AND OBSERVE SAFE LIFTING PROCEDURES DURING ALL MOVES.

The air system can be moved with either a forklift or a standard pallet jack (for modular systems). Keep all packing in place around the dew point sensor and CO sensor during installation to minimize damage.

Walk along the route the unit must travel and note dimensions of doorways and low ceilings. Units should be placed to ensure easy access to perform maintenance and high visibility of indicators and gauges. When installing a modular system, there is no preferred arrangement of modules. The modular design of the components allows for the system to be custom fit to the facility to optimize accessibility and operation.

## Installation Prerequisites



**WARNING:** All air systems should be commissioned by an authorized Amico representative. Failure to do so will void all warranties on the system.

Ensure that the site where the system will be installed has a source of electrical power and that power is of the correct electrical specification as per the design of the system.

## Mounting Position and Space

For maintenance and ventilation of the system, it is recommended that there is 2' (60.96 cm) of clearance around the system and 3' (91.44 cm) of clearance in front of the control panel. Vibration pads are provided for the system to reduce noise caused by the vibration of the system. The system should be leveled and placed on a concrete pad that is suitable to sustain the weight of the system.

The area should have an average ambient temperature of 70°F (21°C) with a minimum ambient temperature of 40°F (4.4°C) and a maximum ambient temperature of 100°F (37.8°C).

# Installation and Commissioning

**NOTE:** At temperatures below 32°F (0°C) the air system will not be adversely affected, but freezing of the condensate can occur which could affect operation.

Sound levels of 76 to 85 dbA are to be anticipated. Though the sound levels are not excessive, they should be considered when choosing the installation location for the system.

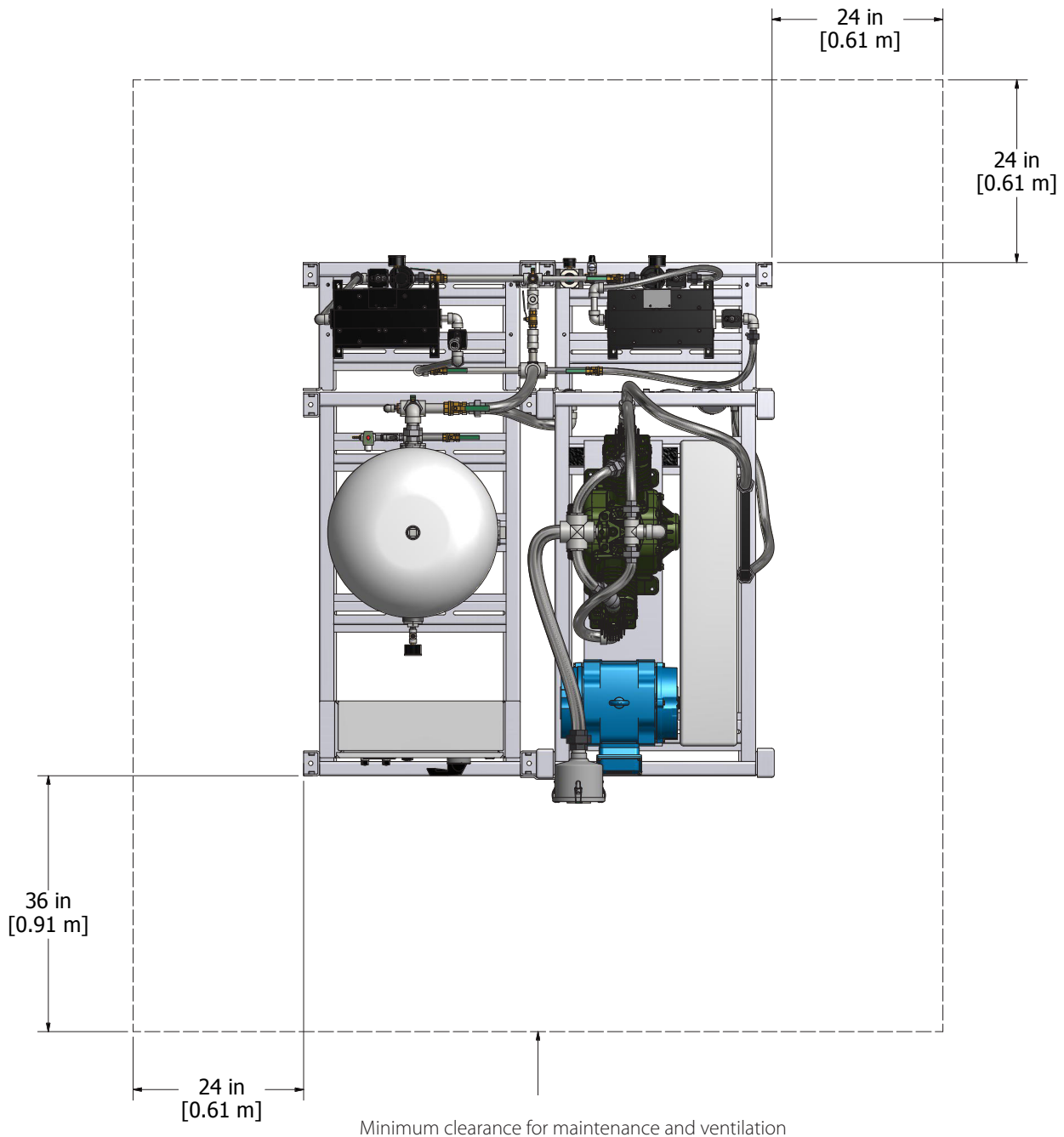

# Piping

## Intake Piping



**WARNING:** The air intake must be placed in an area free of toxic or hazardous contaminants; it must be kept away from ETO gas exhaust vents, vacuum exhaust vents, areas close to automotive exhausts, etc. in accordance with NFPA 99.

The air intake line must be piped in accordance with NFPA 99. To ensure that no restriction of air flow (and thus compressor starvation) will occur, size the piping according to the table on the next page. All pipes must be pre-cleaned for medical gas in accordance with NFPA 99. The outside pipe must be turned down and screened to prevent contamination. The source of air is typically from outside the building. In hot and humid areas, using the building's air-conditioned supply (per NFPA 99) may improve operating conditions of the system.

In the case of modular and SPC systems, all necessary flex connectors (both intake and discharge) are already piped and no further flex connectors are needed. In the case of tank mount systems, only the discharge flex connector is factory piped and the customer must install the intake flex connector.

For 1-5 HP tank mount systems, there is only one intake connection for the system at the common intake filter. At this connection, an elbow should be installed to orient the intake flex connector in the horizontal plane, then brace the end of the flex connector opposite the compressor air filter.

For 7.5-20 HP tank mount systems, there are two intake connections – one at each compressor. At these connections, an elbow should be installed to orient the intake flex connector in the horizontal plane, then brace the end of the flex connector opposite the compressor air filter.

After this point, the two inlet pipes should be connected and piped outside the building per NFPA 99 code.



# Piping

## Intake Pipe Sizing

Unit	Flow Basis <i>SCFM@50 PSI</i> <i>(LPM@345kPa)</i>	Maximum Allowable Equivalent Run (Feet)								
		1.0"	1.25"	1.5"	2.0"	2.5"	3.0"	4.0"	5.0"	6.0"
<i>Nominal Pipe Size:</i>		1.0"	1.25"	1.5"	2.0"	2.5"	3.0"	4.0"	5.0"	6.0"
Duplex 1 Hp	5.0 (141.6)	68	200	500	2000					
Duplex 2 Hp	12.2 (345.5)	22	65	180	650	1800				
Duplex 3 Hp	18.4 (521)		30	70	290	850	2200			
Duplex 5 Hp	30.2 (855)		12	30	120	360	890			
Duplex 7.5 Hp	44.2 (1252)			10	60	180	450			
Duplex 10 Hp Triplex 7.5 Hp	66.3 (1877)			8	35	110	250	1000		
Duplex 15 Hp Triplex 10 Hp Quad 7.5 Hp	108 (3058)				16	48	120	480	1400	
Duplex 20 Hp Triplex 10 Hp	120.8 (3421)					28	70	280	810	
Triplex 15 Hp	132.6 (3755)					25	60	250	750	1800
Triplex 20 Hp Quad 15 Hp	181.2 (5131)					13	33	130	400	1000
Quad 20 Hp	241.6 (6841)						19	80	240	600
Quad 20 Hp	660 (18689)							20	60	140
Quad 20 Hp	880 (24919)							13	40	95

Fittings Equivalent Lengths								
<i>Minimum Nominal Pipe Size:</i>	1.00"	1.25"	1.50"	2.00"	2.50"	4.00"	5.00"	6.00"
Elbows	2.5'	3.0'	4.0'	5.5'	7.0'	12.5'	16.0'	19.0'
Tee (Branch/Run)	4.5'	5.5'/.5'	7'/.5'	9'/.5'	12'/.5'	21'/1'	27'/1.5'	34'/2'

# Piping

## Notes:

1. All pipe sizes are based on the following: copper pipe (Type L).
2. The minimum pipe size must be maintained for the total length of the inlet pipe. Use the next larger size pipe in the event the minimum size is not available.
3. When determining the total pipe length, add all the straight lengths of pipe together in addition to the number of elbows times the effective pipe length for that pipe size. (See the Intake Pipe Sizing table and example below.)

## Example:

To select the pipe size for a Duplex 10 hp with 20 feet of straight pipe and six elbows:

- a. Select the pipe size of 2" diameter for 20 feet of straight pipe.
- b. Determine the Effective Pipe Length (EPL) for an elbow of 2" diameter:  
EPL = 4.9 ft / elbow.
- c. Calculate the System Pipe Length (SPL): 2" D =  $20 + (6 \times 4.9) = 49.4$  ft
- d. Check this System Pipe Length to see if it exceeds the minimum pipe size. In this case it does, so you would select the next larger pipe size from the table (D = 2.5").
- e. To double-check the pipe size, recalculate the SPL with the new diameter.  
SPL: 2.5" D =  $20 + (6 \times 6.4) = 58.4$  ft.

## Discharge Piping

Amico Units	Minimum Discharge Pipe Size
Duplex 2 HP	1/2"
Duplex 3 HP	1/2"
Duplex 5 HP	1/2"
Duplex 7.5 HP	1/2"
Duplex 10 HP	1/2"
Duplex 15 HP	1/2"
Duplex 20 HP	1"
Triplex 10 HP	1"
Triplex 15 HP	1"
Triplex 20 HP	1"
Quad 10 HP	1"
Quad 15 HP	1"
Quad 20 HP	1.5"

**Note:** A larger discharge pipe size may be required depending on the length of distribution piping in the facility. However, the distribution pipe size should not be less than the minimum pipe size shown in the above table. For larger sized systems, please contact Amico Source Corporation.

# Wiring



**WARNING:** BE SURE TO DISCONNECT ALL ELECTRICAL POWER FROM THE SYSTEM BEFORE PERFORMING ANY ELECTRICAL PROCEDURES.

Refer to the electrical diagram provided with the unit before starting any installation or maintenance work.

**Do not operate system on a voltage other than the voltage specified on the system panel.**

All customer wiring should be in compliance with the National Electrical Code and any other applicable state or local codes.



**CAUTION:** All voltages will be disconnected from the compressor and dryer modules using the circuit breaker. Opening the appropriate fused knife-switch disconnects control power. Turning off the appropriate motor circuit breaker disconnects motor power.

**Refer to the wiring diagram(s) that came with the compressor system for pertinent wiring connections.**

Check the control voltage, phase and amp ratings before starting the electrical installation and make sure the voltage supplied by the hospital is the same. The wire size should be able to handle peak motor amp load of all operating units. Refer to the specifications for full load and compressor system amperes on the wiring diagram.

Check all electrical connections within the air system that may have loosened during shipment.

Only qualified electricians should make power connections to the control panel and any interconnecting wiring.

Ensure that the electrical supply for the emergency generation system is consistent with the air system's requirements.

Three-phase power supplied from emergency generator(s) must match that of the normal supply to allow for correct motor rotation direction at all times.

# Installing the Dew Point Sensor

The dew point sensor is shipped separated from the system and is stored within the Control Panel. To install the dew point sensor, please follow the instructions below:

1. Remove the sensor from package
2. Remove the cover on the dew point sensor



**WARNING:** Do not touch the sensor tip. This is sensitive equipment and contamination will cause the dew point readout to be inaccurate.

3. Insert the dew point sensor into the pipe and tighten to a minimum of 22.5 lb. ft (30.5 Nm)
4. Connect the dew point wire to the sensor and secure the wire to the sensor

## Control Panel

### System Overview

The Premium series controllers are based on pressure transducers. Every controller will have a color touch screen (HMI) that will allow for process variables adjustment; alarm set points adjustment; visual indication of system faults; current pressure level as well as each pump status including pump faults, pump duty in sequence and elapsed run time. Air controllers will also show the CO level and Dew Point levels and alarms as well as tower switching failure. All pumps will have a circuit breaker through the door disconnect and illuminated H-O-A switches. Air controllers will have a dryer selector switch as well.

Controllers are factory wired for a single power source and a power distribution block is provided for power connection. The system will accept separate power feeds for each pump in case the power distribution block is removed for redundancy purposes. A minimum of two control transformers will be provided. In case the primary transformer fails, a secondary transformer automatically provides control power. Power switching relay(s) are provided to switch primary transformer windings to any available power source if separate power feeds are used.

# Control Panel

## Sequence of Operation

Operation of the controller is based on “ON” and “OFF” setpoints. (See “Setpoints Adjustment” for instructions on how to adjust setpoints).

The lead pump will switch on when pressure drops below the “ON” setpoint and shuts off when pressure reaches the “OFF” setpoint. Every time the lead setpoint is satisfied, the next available pump will become the lead pump.

Lag and all reserve pumps (if applicable) will switch on when the pressure level drops below the respective “ON” setpoints and will switch off when respective “OFF” setpoints are reached.

**Note:** See “System timers” for additional information on pump sequencing).

If a pump is switched off by an H-O-A switch or a pump fault is detected, it will be automatically taken out of the sequence and its duty transferred to the next available pump. Once the fault is cleared (See “Troubleshooting” for additional information) and the H-O-A switch is in the “A” position, the pump will be automatically included into the sequence.

1. Display Screen – Displays the systems operating screens, available in Pro IEC or ECO+ displays
2. Touch Monitor – For changing different settings on the display screen
3. H-O-A Selector Switch – Pump control switch: Hand/Off/Auto
4. Alarm Horn – Sounds when an alarm condition occurs
5. Alarm Silence – Silences alarm to allow work to be performed without the annoyance of the alarm
6. Alarm Reset – Resets all alarm states after the condition that set off the alarm is corrected; do not reset the alarm until the type of alarm has been recorded and the alarm cause identified and corrected to the best of your ability
7. Power Breaker – Controls the power to each pump and the control panel



# Control Panel

## Main Screen

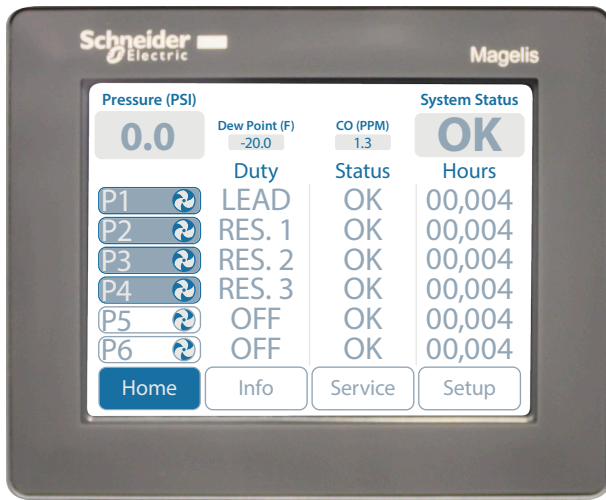

Pro IEC Display Screen

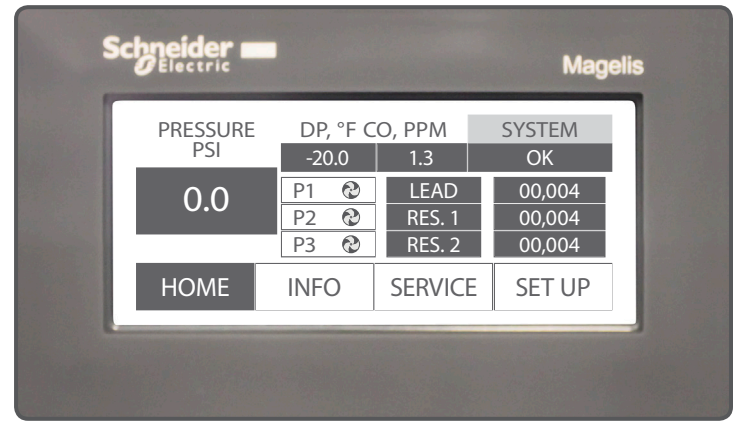

ECO+ Display Screen

### Pump Duty

Displays the following:

- If H-O-A switch is in the "O" (OFF) position, it will read "OFF"
- If pump is running, it will read "RUN" regardless of the H-O-A position
- If pump is off and the H-O-A switch is in "A" (AUTO) position, it will read the duty of the pump: LEAD, LAG, RES1 (RESERVE 1), RES2 (RESERVE 2) as applicable
- If a pump is in critical fault, it will read "OUT OF SERVICE"

### Pump Status

Displays the following:

- If a pump is in critical fault and the H-O-A switch is in "A" (AUTO) position, it will read "FAULT"  
**Note:** even if the reason for the fault is cleared (e.g. an "OVERTEMP" alarm is cleared and reset), the status of the pump will remain in "FAULT." To reset pump status, the respective H-O-A switch must be turned to "O" (OFF) position. (See "Troubleshooting" for additional information)
- If a pump is in non-critical fault (e.g. maintenance is suggested), it will read "ATTENTION REQUIRED!"
- If a pump is in normal operating condition, it will read "OK"

### Run Time Display

- Run time for each pump is displayed in hours

### Pressure Display

- Current pressure is displayed in PSI
- In case the pressure transducer fails, all pumps will shut off and "SENSOR FAILED" will be displayed instead of the pressure readout. After the sensor is repaired, push the reset button to reset sensor fault. (See "Troubleshooting" for additional information)

### CO Display – Air Controllers Only

- The current CO level is displayed in ppm (parts per million)

# Control Panel

## Dew Point Display – Air Controllers Only

- Current Dew Point level is displayed in °F or °C (See “Troubleshooting” for additional information)

## System Status Display

- If no system faults are present, it will read “OK.” If any unit alarms are present, it will read “FAULT! CLICK HERE.” By clicking on the message, a units alarms screen will be displayed where specific alarms can be viewed. (See “Troubleshooting” for additional information)

## Pump Detail Screen



Pro IEC Display Screen

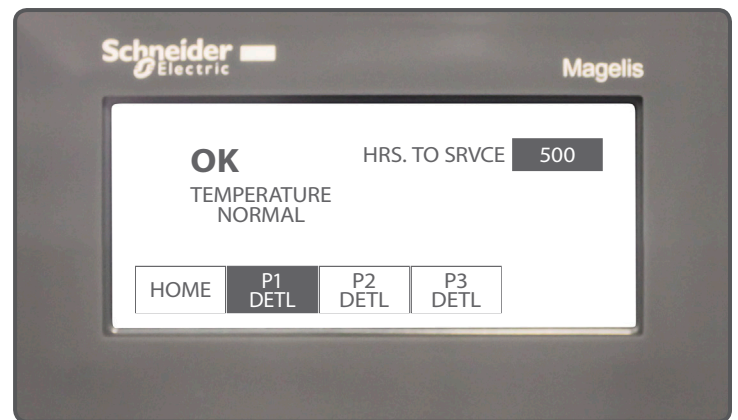

ECO+ Display Screen

The Pump Detail screen can be accessed from the main screen by pressing the respective “P #” button. It will display the current pump status, hours left until service is required, the temperature readout for each head if RTD sensors are used, pump faults and alarms (See “Troubleshooting” for additional information).

## Setpoints Screen

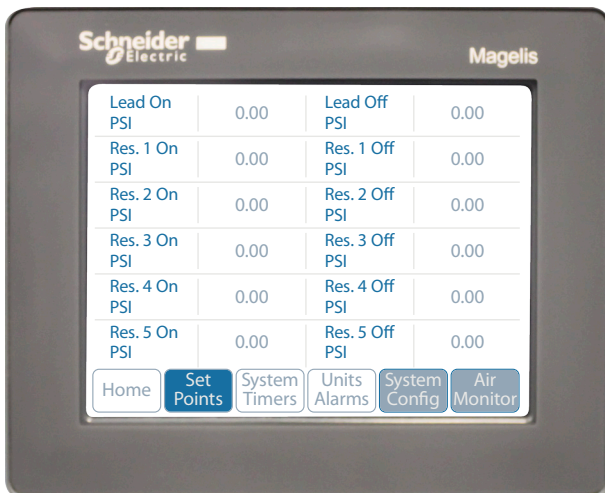

Pro IEC Display Screen

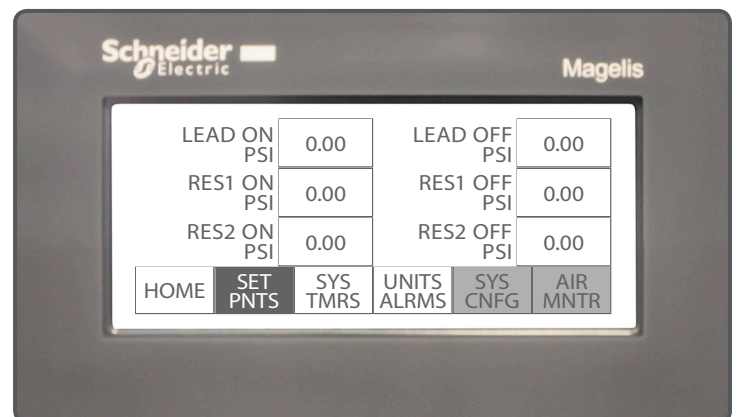

ECO+ Display Screen

The pressure Setpoints screen can be accessed from the main screen by pressing the “SET UP” button. “ON” and “OFF” setpoints can be adjusted by pressing the respective values. A numeric keypad will appear, allowing direct value entry.

# Control Panel

**Note:** The system has the following restrictions:

- It will not accept “OFF” entry values lower than “ON” values
- Lag and all subsequent Res. (if applicable) “ON” and “OFF” values cannot be higher than previous “ON” and “OFF” values

## System Timers Screen

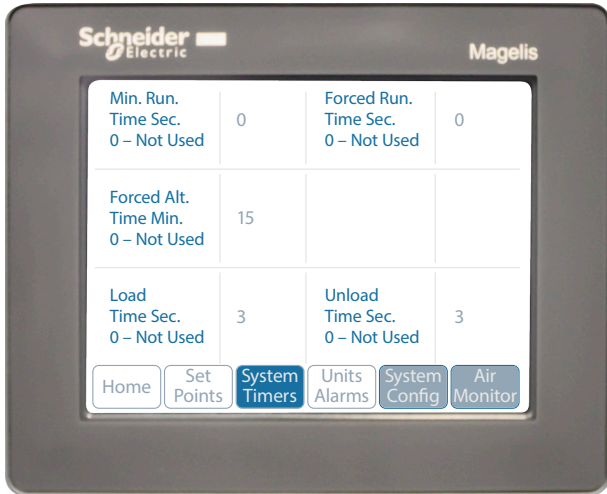

Pro IEC Display Screen

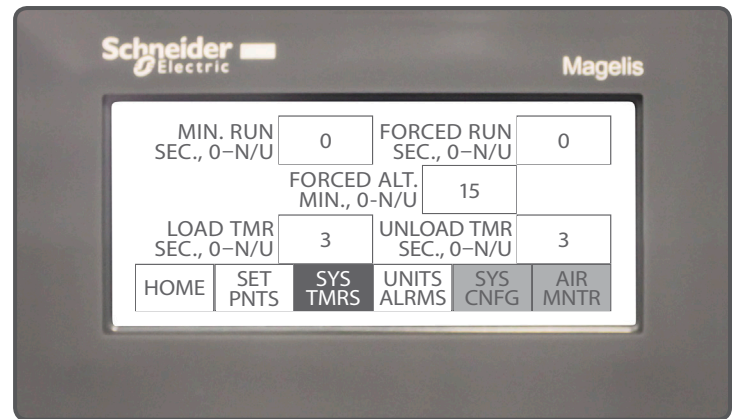

ECO+ Display Screen

The System Timers screen can be accessed from the main screen by pressing the “Set Up” button and then pressing “System Timers.” It will display the minimum run timer, forced run timer and forced alternation timer.

### Minimum Run Timer

The value of this timer is in seconds. This is the time that the pump will run after it has been switched on in automatic mode regardless of pressure level. For example, if it is set to 600 seconds (10 minutes) and a respective pressure setpoint is satisfied in 5 minutes, the pump will run for 5 more minutes and then shut down. If a respective pressure setpoint is satisfied in 13 minutes, the pump will shut down immediately upon switch satisfaction. The value “0” will turn this timer off.



**WARNING:** ALL AIR SYSTEMS SHOULD HAVE THIS SET TO “0” SECONDS. FAILURE TO DO SO WILL VOID THE WARRANTY.



# Control Panel

## Forced Run Timer

The value of this timer is in minutes. This is the time that will take to switch the next available pump on if the lead setpoint (SP1) is not satisfied within this period. For example, if it is set to 15 minutes and the lead pressure setpoint is not satisfied within this time with the lead pump running, then the lag pump will be switched on. If the lead setpoint is still not satisfied within the next 15 minutes, the reserve pump (if applicable) will be switched on. All pumps will run until the lead setpoint is satisfied. If a minimum run timer is used (see “Minimum Run Timer” section above), pumps that ran less than the minimum run timer setting will continue to run until their minimum run time elapses. The value “0” will turn this feature off.

**Note:** If lag and reserve (if applicable) pumps are switched on by their respective pressure setpoint, they will continue to run until the lead setpoint is satisfied.

## Forced Alternation Timer

The value of this timer is in minutes. This is the time that will take to alternate the pumps in case the lead setpoint was not satisfied within the specified time period. For example, if this timer is set to 480 minutes (8 hours) and the lead setpoint is not satisfied within this period, all pumps will be shut off briefly and the next lead pump will be switched on. The value “0” will turn this feature off.

**Note:** Even with this timer active, normal alternation on each cycle will occur.

## Alarms Setpoint Screen

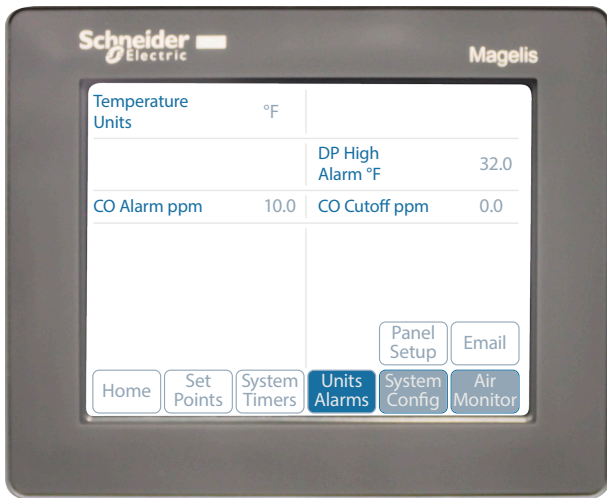

Pro IEC Display Screen

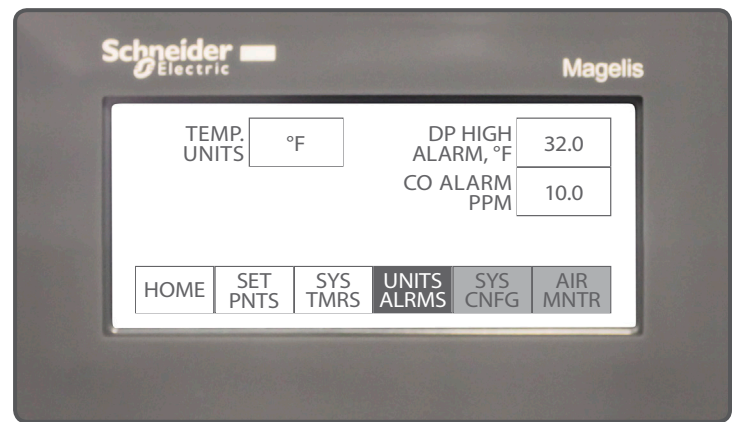

ECO+ Display Screen

This screen can be accessed from the main screen by pressing the “SET UP” button and then pressing “Units Alarms”. It allows entering settings for the following alarms:

# Control Panel

## Overtemp Alarm

This alarm setpoint is available if system is based on RTD temperature sensors to monitor the pump head temperature. If the system uses temperature switches instead, this setpoint is not available. The setpoint is in °F or °C. That can be toggled by pressing the Temperature Units value field. Up/Down arrows will appear and you can use these to switch between units of measure. Press “ENTER” to confirm. Touch the Overtemp Alarm value field so that a numeric keypad appears to allow direct value entry.

## CO High Alarm

This alarm setpoint is available for air controllers and if equipped with a specific CO monitor only. The setpoint is in ppm. Touch the CO High Alarm value field. A numeric keypad will appear to allow direct value entry.

## Dew Point High Alarm

This alarm setpoint is available for air controllers and if equipped with a specific DP monitor only. The setpoint is in °F or °C. That can be selected by pressing the Temperature Units value field. Up/Down arrows will appear and you can use these to switch between units of measure. Press “ENTER” to confirm. Touch the Dew Point High Alarm value field and a numeric keypad will appear to allow direct value entry.

## System Log Screen

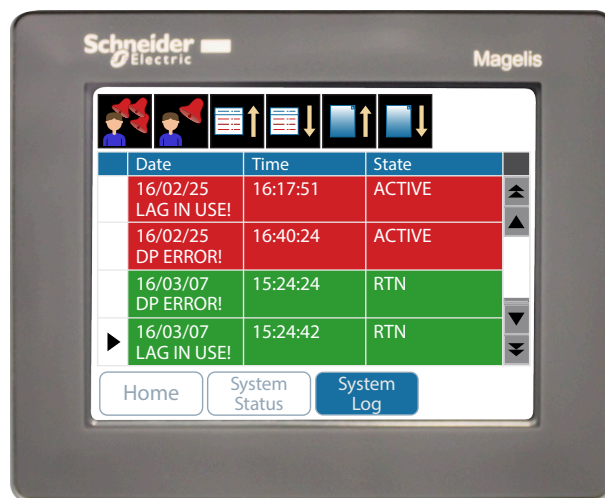

Pro IEC Display Screen

The System Log keeps track of all of the alarms on the system. The information provided in the log can be used for troubleshooting purposes.

# Control Panel

## System Information Screen

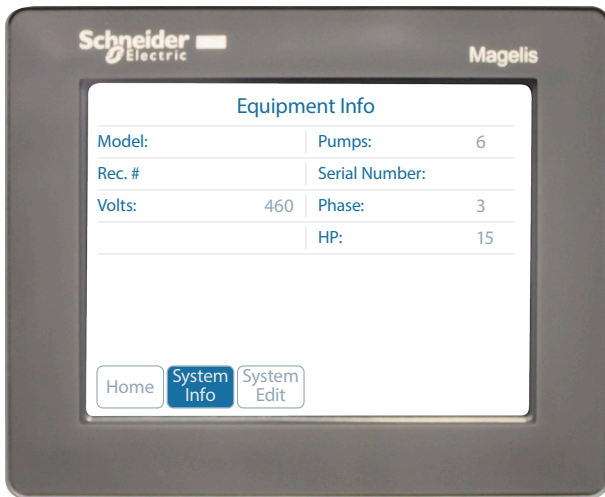

Pro IEC Display Screen

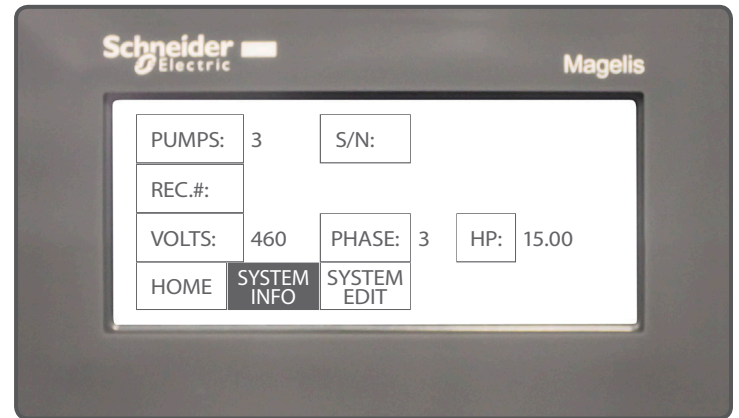

ECO+ Display Screen

This screen can be accessed from the main screen by pressing the "System Info" button. It will display general system information.

## Service Information Screen

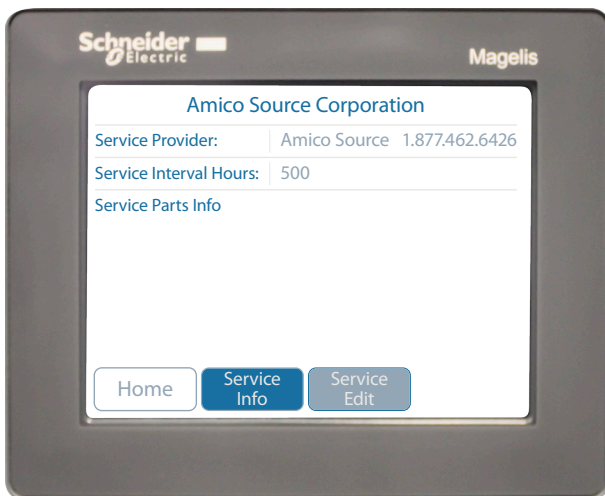

Pro IEC Display Screen

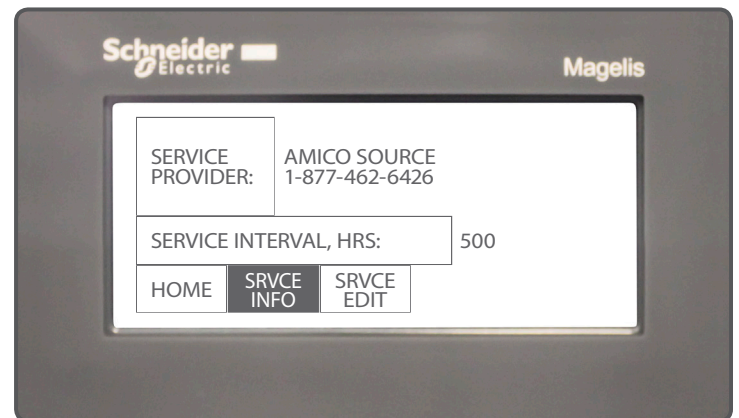

ECO+ Display Screen

The Service Information screen can be accessed from the main screen by pressing the "System Info" button and then pressing "Service Info" or by pressing on the "Service Needed" message if it has appeared. It will display the service provider's information, maintenance interval and other service information.

# Control Panel

## Dryer Control Screen

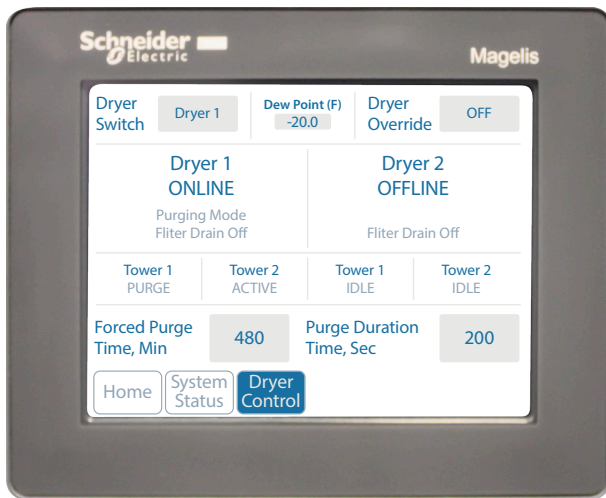

Pro IEC Display Screen

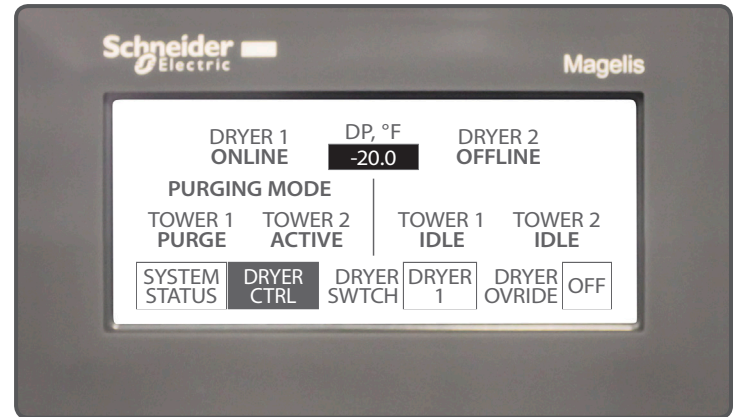

ECO+ Display Screen

The Dryer Control screen can be accessed from the main screen by press on the top right “System Status”. On the right, you will see “Dryer Control”. The operation of the setting is as follows:

### Dryer Switch

This setting allows user to change the use of the dryer. By pressing on it, it will allow user to select Dryer 1 or Dryer 2. When the dryer is selected, it will bring a 4 minutes purging cycle according to the set value in “Purge Duration Time, Sec” which will be described later in this section. Note this setting only change the operation of the electronics and does not change the position of the ball valve. You will need to follow the instruction under the section “Dryer Rotation”.

### Dryer Override

When this is selected on, both dryer will operate. The dryer selected under “Dryer Switch” will continue to operate as normal. The other dryer that is not selected will follow the purge cycle regardless of dew point. This setting is use to assist in regenerating the dryer should there be any issues. Please contact Amico Source Technical Support to gain a further understanding on when to use this function. During normal operation, this setting should be selected “Off”.

### Dryer Status

The screen will provide you with the status of each dryer and each tower. If the dryer is “OFFLINE”, the ball valve in the system should be selected accordingly. Please refer to “Dryer Rotation” section for details.

### Purging Mode

During this mode, the dryer will follow a purge cycle set by “Purge Duration Time, Sec”.

# Control Panel

## Economy Mode

When the dew point reaches -25F (-31.7C), the dryer will enter "Economy Mode" where it will stop the purging cycle. In this mode, it will only purge under two condition: 1. "Force Purge Time, Min" is reached since it entering "Economy Mode" and the dryer will only purge once to switch tower or, 2. The dew point has raised to -20F (28.9C) and the dryer is switched back to "Purging Mode".

This setting can be changed if needed. Please contact Amico Source Technical Support for instruction on changing this setting.

## Tower Active

This indicates that the tower is now producing air to the facility.

## Tower Purging

This indicates that the exhaust valve for that tower is open and is purging the tower.

## Tower Recover

This indicates that the tower is now re-pressurizing after purging.

## Tower Idle

This indicates that the tower is idle and is not under any operation.

First Cycle		Second Cycle	
Tower 1	Tower 2	Tower1	Tower 2
Active	Purging	Purging	Active
	Recover	Recover	

## Force Purge Time, Min.

When dryer is in "Economy Mode", it will stop switching tower. This cause excessive wear on one tower's desiccant for lower usage facility. To balance out the usage of desiccant under low usage situation, a "Force Purge Time, Min." is used. In "Economy Mode" the dryer will stop purging and the counter will start timing. When it reaches the set time, the dryer will do 1 purge cycle then return to Idle again. This will effectively switch the tower in used.

## Purge Duration Time, Sec.

The "Purge Duration Time, Sec." is to set the amount of time that the exhaust valve will opening during the 4 minutes purge cycle. The decrease in time will allow compressor to catch up easier but will decrease the effectiveness of each purge. Amico Source suggest this to be set to 200 seconds. Please contact Amico Source Technical Support should you wish to change this setting.

## Returning to the Home Screen

From any subscreen, you can press the "Home" button or "Exit" to return to the Home screen.

# Reciprocating Air Compressor

Amico Reciprocating Air Compressors have a renowned reputation for manufacturing the most reliable and efficient compressors. To achieve this high performance, a few key features are used in these compressors:

## High Cooling Head

The high cooling head with long aluminum alloy cooling fins improves the cooling efficiency of the compressor. In addition, the V-groove located between the discharge and suction chamber reduces the heat transfer from the discharge chamber to the suction chamber, thereby improving the air capacity (flow rate) of the compressor.

## Air Valve

The air valves used in the compressor is of an I-shaped stainless steel suction air valve design. This design allows for improved air capacity and resistance against rusting.

## Heat Reduced Piston Pin

The piston pin is made of heat-insulating material. This design reduces the heat transfer from the piston to needle bearing, keeping the bearing at relatively low temperatures and improves the reliability of the compressor.

## Leak Reduced Piston Ring

The piston ring is shaped as an abutment joint which reduces air leakage and improves the air capacity of the compressor.

## Compression cycle

The piston is driven by a rod passing through a packing case (to seal against pressure leaks). With this design, gas can be compressed on both sides of the piston and constant air flow can be achieved. In each head of the Reciprocating Compressor there is a piston which undergoes a suction phase and a discharge phase. During the suction phase, the piston pulls in air which is being provided to the system at the air inlet. When the cylinder is filled with air, the piston proceeds with the discharge phase. This discharge phase compresses the air as the piston is pushing the air out of the cylinder through small exhaust ports at high speeds. This process continues until the demand for pressure is satisfied. Since multiple cylinders are included on the compressor, the air flow is continuous for entire operation of the compressor.

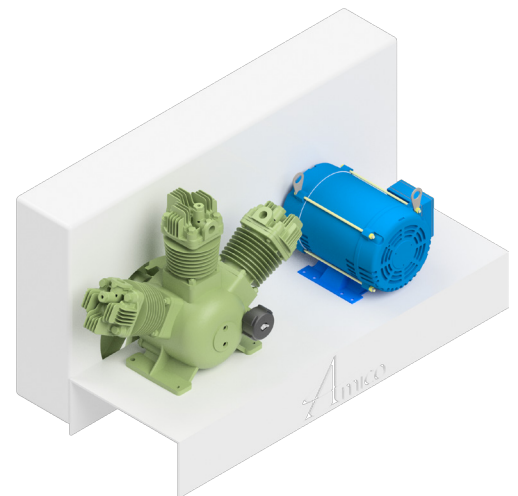

Reciprocating Compressor

# Reciprocating Air Compressor

## Compressor Pressure Settings

System Pressure Switch Factory Settings	Start (Close)	Stop (Open)
Lead (PS-1)	80 psig	100 psig
Lag 1 (PS-2)	75 psig	95 psig
Lag 2 (PS-3)- Tpx and Qpx Only	70 psig	90 psig
Lag 3 (PS-4)- Qpx Only	65 psig	85 psig

For maintenance or other reasons, the compressors can operate in the “Hand” position. In this condition, the compressor in the “Hand” position will start when the switch is held in hand and will continue to run until the switch is let go. These pressure conditions must be programmed into the control panel and set into the pressure switches. These values of pressure must be set to ensure safe operation for the compressors and to avoid damage to the air tank.

# Heatless Desiccant Dryer

## The Heatless Desiccant Dryer in the System Comes Standard With:

- Electronic drain valve on the inlet filter
- A built-in, 3-micron particulate afterfilter (within the diffuser screen or compactor plate) to protect downstream equipment from desiccant fines

## Design

The air enters an oil coalescing filter (optional) which removes the oil carryover from the compressor in the air stream. Then it enters a coalescing pre-filter where solids and condensates (oil/water mixture) are filtered through a 0.01  $\mu$  element. The heatless regenerative dryer then adsorbs moisture from the compressed air stream down to a pressure dew point (PDP) of  $-40^{\circ}\text{F}$  ( $-40^{\circ}\text{C}$ ) at standard inlet conditions:  $100^{\circ}\text{F}$  ( $37.8^{\circ}\text{C}$ ), 100% saturated, 100 psig.

The built-in afterfilter removes any desiccant fines before they can travel downstream. An afterfilter installed after the dryer further removes any desiccant fines that are carried over with a 1  $\mu$  element. To further remove any contaminants in the air, the air passes through an optional activated carbon filter and an optional medical grade sterile filter.



Each system contains two dryers as per NFPA 99. During normal operation, one dryer will be powered on and the other will be deactivated and on standby. For instructions on switching the active dryer, please refer to the maintenance section of this manual.

## Contents

Each dryer consists of:

- Two aluminum towers filled with desiccant
- Two aluminum blocks including air seals and check valves
- Two solenoid pilot valves
- Built in afterfilters
- One pressure gauge
- Two mufflers
- Electronic auto drain

## Operating Principles

Wet air enters the filters and flows from the top block to the lower block via air transfer tubes. Air then flows to the shuttle inlet valve and is diverted to tower #1. The compressed air flowing through tower #1 is dried to a  $-40^{\circ}\text{F}$  ( $-40^{\circ}\text{C}$ ) PDP and exits via the outlet filter.

A small portion (12%) of the compressed air is expanded to near atmospheric pressure by passing through the purge orifice. Expansion of this already dry gas to near atmospheric pressure increases the ability of the purged air to strip the previously adsorbed water vapor from the partially saturated desiccant bed in tower #2.

The air exhausts through the opened two-way purge valve.



**CAUTION:** At the end of pressurization, the regeneration tower will depressurize producing a loud noise.



# Dew Point Sensor

The Amico system is equipped with a Dew Point Sensor which provides the readout of the dew point. The readout is integrated into our panel and all settings are preset. If you are changing your dew point sensor to a different style, please contact Amico Source Corporation Technical Support for assistance.

The original Dew Point Sensor is shipped within the control panel to prevent it from being damaged. Please refer to installation instructions to install the Dew Point Sensor.

The sensor cable should be connected to the control panel by two terminated wires as shown in the following table. The sensor connector terminations are shown for reference (supplied pre-wired).

Function	Power (+24 VDC)	4-20 mA
	Red Wire	White Wire
<i>Sensor Connector (Pre-wired)</i>	Pin 3	Pin 1

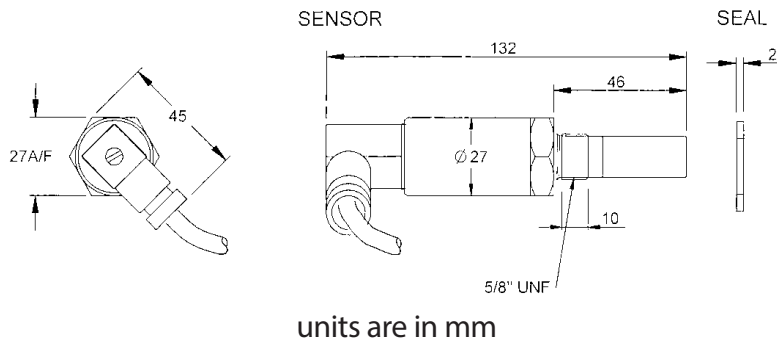

## Technical Specifications

<i>Sensor Torque Loading:</i>	Minimum 22.5 ft-lbs (30.5 Nm)
<i>Calibration range:</i>	-148°F to +68°F (-100°C to +20°C) dew point
<i>Output:</i>	4-20 mA current source over the entire dew-point range
<i>Dewpoint accuracy:</i>	±3.6°F (±2.0°C)
<i>Operating environment:</i>	-40°F to +140°F (-40°C to +60°C)
<i>Operating humidity:</i>	0-100% RH
<i>Operating pressure:</i>	45 MPa (450 barg/ 6500 psig) max
<i>Flow rate:</i>	2.1 to 10.6 SCFH (1 to 5 liters/minute) mounted in standard sampling block 0 to 32.8 feet/second (0 to 10 meters/second) direct insertion
<i>Housing material:</i>	Stainless steel
<i>Weight:</i>	0.33 lbs (0.15 kg)

# CO Transmitter

The CO transmitter uses an electrochemical sensor to convert a gas concentration into a linear, 4–20 mA electrical signal and transmits it via cable to a controller. It is an easy to connect, loop powered, two wire transmitter.

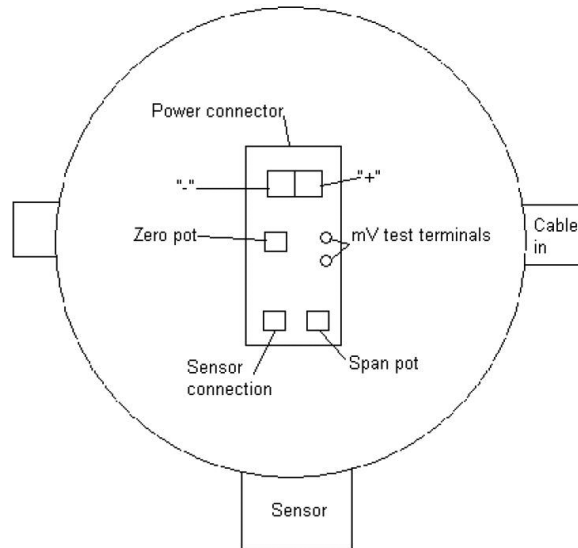

## Technical Data

<i>Gas and Detection Range</i>	Carbon Monoxide to 300 ppm
<i>Detection principle</i>	Electrochemical
<i>Gas supply</i>	Supplied
<i>Response time T90</i>	< 30 seconds
<i>Output signal</i>	4–20 mA Linear
<i>Voltage supply</i>	10–30 VDC
<i>Sensor Cable</i>	18 AWG 2 conductor shielded
<i>Relative Humidity</i>	15–95% rh non-condensing

## Maintenance

### Air Compressor



**WARNING:** BEFORE STARTING ANY MAINTENANCE PROCEDURES, DISCONNECT ALL POWER TO THE PACKAGE.

Release all pressure from the package before removing, loosening, or servicing any covers, guards, fittings, connections, or other devices.

Never perform any maintenance functions while the unit is in operation.

# Maintenance

Check Items	Procedures	Schedule				Remarks
		Daily	Every 500 Hours or 1 Month	Every 3,000 Hours or 1 Year	Every 8,000 Hours or 2.5 Years	
Complete Compressor	Inspect for excessive noise and vibration	Inspect				
Pressure gauge, unloader valve, pressure switch and safety valves	Check operation status	Inspect				
Loose bolt, screw, nut	Tighten them with standard wrench/screwdriver		Inspect			
Belt	Replace frayed belt and slide the motor for slack belt		Inspect	Replace		See Tension Check below
Inlet filter, crank case filter	Inspect for clog or excessive dirt		Inspect			See below for instructions for crank case filter, replace if necessary
Piston ring	Check thickness			Inspect	Replace	Replace if necessary
Rider ring	Check operation status			Inspect	Replace	Replace if necessary
Bearings	Ball Bearing	Check the ball bearing for rotating condition and for grease leakage		Inspect	Inspect	Replace if necessary
	Needle roller bearing					
Unloader piston	Check attrition at engaging part and grease deterioration			Inspect	Replace	Replace if necessary
Cylinder	Check attrition at engaging part			Inspect	Inspect	Replace if necessary

## Crankcase Filter

Checking and cleaning of the crank case filter.

1. Remove the cover of the air intake filter.
2. Remove the element, clean it by brush, and blow it with an air nozzle.

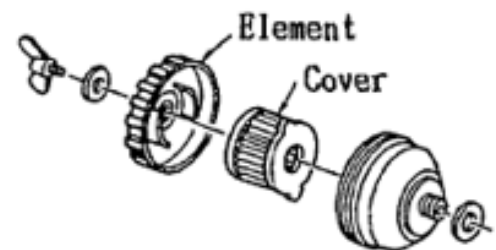

**CAUTION:** WHEN CLEANING, BE CAREFUL NOT TO ALLOW DUST INTO YOUR EYES AND MOUTH.

# Maintenance

## V-Belts

Narrow type V-belts are used for this unit. Refer to the table below for the correct size.

### Tension Check – Belt Size and Tension (for New Belts)

Model	Belt Part Number	Force (lbs)	$\sigma$ , Deflection (mm)	
1 HP	BELT-4L540	4.4	0.25	0.39
2 HP	BELT-5L590	4.4	0.25	0.39
3 HP	BELT-B61	4.4	0.25	0.39
5 HP	BELT-3VX670	6.6 (New belt 8.8)	0.25	0.28
7.5 HP	BELT-5V850	8.8 (New belt 11)	0.25	0.35
10 HP	BELT-5V850	11 (New belt 14)	0.25	0.37
15 HP	BELT-15HP-V-5VX840	13 (New belt 15)	0.25	0.43
20 HP	BELT-5V950	13 (New belt 15)	0.25	0.43

\*Parts on the table are for reference only. Please verify belt part number with Amico Source Corporation for the correct belt.



**WARNING:** BE SURE TO TURN OFF THE MAIN DISCONNECT SWITCH WHEN ADJUSTING TH V-BELT.

Release all pressure from the package before removing, loosening or servicing any covers, guards, fittings, connections or other devices.

Never perform any maintenance functions while the unit is in operation.

Check the belt tension monthly. Disconnect the main power and remove the belt guard.

As shown in the illustration at right, deflect each V-belt at the center of the drive span with a spring balance or tension meter at the tension force indicated in the table above. Then check that the average deflections at the proper tension force are approximately the same values as shown in the table above.

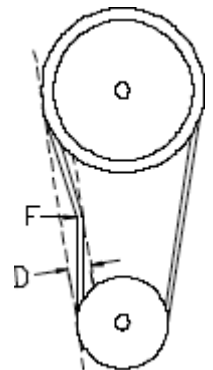

If necessary, adjust the V-belts until the average deflections are within the values shown in the table above.

#### To Tighten the V-belts:

1. Remove the belt guard.
2. Loosen the two locking bolts securing the motor base.
3. Turn the belt tensioning adjustment rod on the motor base and rotate the motor downward until the proper tension and alignment is obtained. To check for correct alignment, place a straight edge on the faces of the two sheaves. Proper alignment is obtained when all the gaps between the straight edge and the sheaves are minimized and less than 1/8" (3.18 mm).

# Maintenance

4. Check the belt tension again and make sure the tension is similar to the values listed in the “Tension Check – Belt Size and Tension” table above.
5. Replace the belt guard before operating the machine.



**CAUTION:** IF THE COMPRESSOR IS OPERATED WITH LOOSE V-BELTS OR IMPROPER SHEAVE ALIGNMENT, THE LIFE OF THE V-BELTS IS SHORTENED. EXCESSIVE TENSION CAN BREAK THE SHAFT OR REDUCE BEARING LIFE. BE SURE TO MAINTAIN PROPER V-BELT TENSION AND ALIGNMENT.

## Changing the V-Belts

V-belts should be changed every 8,000 hours under normal operating conditions. If any damage is found, they should be replaced at once. To change the v-belts, call the nearest Amico distributor or follow the procedures described below:

### To Change the Belts

1. Remove the old belts:
  - Remove the belt guard.
  - Loosen the locking bolts securing the motor base.
  - Turn the belt tensioning adjustment rod on the motor base and rotate the motor upward.
  - Remove the old belt(s).
2. Check and clean:
  - Check and clean all of the grooves of both the motor and compressor sheaves.
  - Check the tightness of bolts on the sheave bushings.
3. Installation of new belts:
  - Confirm the belt type and length.
  - Place the belt(s) into the grooves of both sheaves.
  - Tighten the V-belt as per instruction above.



**WARNING:** BE SURE TO TURN OFF THE MAIN DISCONNECT SWITCH WHEN ADJUSTING TH V-BELT.



**CAUTION:** IF THE V-BELT IS TENSED TOO STRONGLY, THE LIVES OF THE BEARINGS ARE SHORTENED.



**CAUTION:** IF THE V-BELT IS STAINED WITH OIL, DUST, ETC., ITS LIFE WILL BE SHORTENED. AVOID ANY CONTACT WITH OIL. DUST, ETC.

## Piston Ring and Rider Ring

When checking these rings, if any one of them is found worn off to the thickness limits shown below, both must be replaced by new ones.

Model HP	Initial thickness in radius direction inch (mm)		Limit thickness in radius direction (mm)	
	Piston Ring	Rider Ring	Piston Ring	Rider Ring
1	0.18 (4.5)	0.055 (1.4)	0.14 (3.6)	0.0472 (1.2)
2	0.25 (6.5)	0.079 (2.0)	0.19 (4.9)	0.0630 (1.6)
3	0.25 (6.5)	0.079 (2.0)	0.19 (4.9)	0.0630 (1.6)
3	0.25 (6.5)	0.079 (2.0)	0.19 (4.9)	0.0630 (1.6)
7.5	0.25 (6.5)	0.079 (2.0)	0.19 (4.9)	0.0630 (1.6)
10	0.35 (9.0)	0.106 (2.7)	0.29 (7.4)	0.0787 (2.0)
15	0.35 (9.0)	0.106 (2.7)	0.29 (7.4)	0.0787 (2.0)
20	0.35 (9.0)	0.106 (2.7)	0.29 (7.4)	0.0787 (2.0)

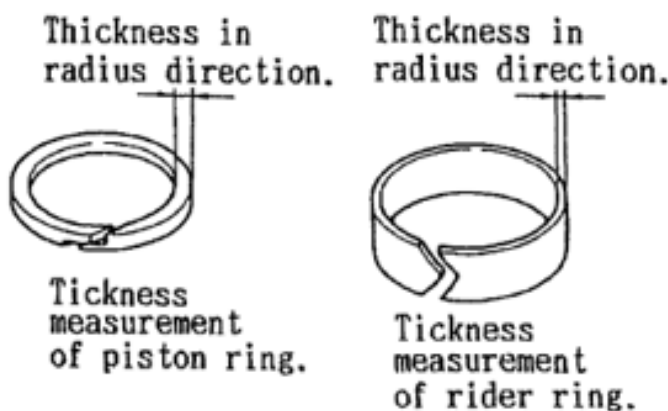

**WARNING:** NEVER FAIL TO TURN OFF THE MAIN POWER BEFORE DISSASSEMBLING THE COMPRESSOR FOR REPLACING ANY PARTS. REPLACEMENT INTERVAL OF BEARING, PISTON RING, RIDER RING AND OIL SEAL SHALL BE 8,000 HOURS UNDER NORMAL USE, AND SHALL NOT EXCEED 8,000 HOURS OR LONGER IN ANY CASE.

**CAUTION:** WHEN OPERATION IS STOPPED FOR A LONG PERIOD OF TIME, NO-LOAD OPERATION SHOULD BE DONE FOR MORE THAN 30 MINUTES, ONCE A MONTH, BECAUSE THE GREASE LIFE WILL BE SHORTENED DUE TO HUMIDITY.

Observe the following points to prevent the operation failure due to rusting.

1. Operate in the following way every 6 months:
  - No-load operation for 10 minutes
  - Increase the pressure and check the control pressure
  - Subsequently, operate for 10 minutes under no-load and then stop
2. For storing, select a place with low humidity levels and free from dust

# Maintenance

## Heatless Desiccant Dryer

Check Items	Procedures	Schedule			Remarks
		Weekly	Every 500 hours or 1 month	Every 3000 hours or 1 year	
Purge Cycle	Observe the dryer is performing a purge cycle every 4 minutes	Inspect			
Purge	Place hand below dryer and check if air is purging from both towers	Inspect			
Filter	Check gauge for back pressure, replace element as needed	Inspect		Replace	
Dryer Rotation	Change dryer unit		Inspect		Please refer to instructions below
Dryer Annual Maintenance	Perform annual maintenance			Replace	Please refer to instructions below
Dew Point Sensor	Perform calibration			Replace	Please refer to instructions below
CO Transmitter	Perform calibration			Replace	Please refer to instructions below

### Switching Dryers

Dryer should be rotated every 500 hours or once a month. This will allow both dryers to wear evenly and prolong the use of this dryer package.

For the ease of understanding these instructions. The dryer that is currently online will be referred to as the active dryer and the dryer that is currently offline will be referred to as the standby dryer.



**CAUTION:** FAILURE TO FOLLOW THE INSTRUCTION BELOW COULD RESULT IN THE LOSS OF MEDICAL AIR SUPPLY.

1. Slowly open the inlet ball valve to the standby dryer in order to pressurize the dryer. The inlet ball valve should be opened slowly to prevent damage the desiccant beads inside the desiccant dryer. Wait until the line is fully pressurized.
2. On the control panel screen under "Dryer Control", select "Dryer Override" to "On". Wait for the standby dryer to complete a few purge cycles (approximately 16 to 20 minutes).
3. Open the discharge ball valve of the standby dryer and allow the dew point to stabilize. If dew point rises above alarm point, close the discharge ball valve to the standby dryer. Allow the standby dryer to complete a few purge cycles before trying this step again. If dew point persists to be high after a couple attempts, please refer to the troubleshoot section in the O&M manual or contact Amico Source Technical Support Team.

# Maintenance

4. Once the dew point stabilizes, shut the discharge ball valve then the inlet ball valve of the active dryer.
5. On the control panel screen, select “Dryer Switch” to select the standby dryer and select “Dryer Override” to “Off”. If at this point the dew point rises above the alarm point, please switch back to the active dryer and contact Amico Source Technical Support Team.

## Dryer Annual Maintenance

It is recommended by Amico Source Corporation that you replace the following parts annually as preventative maintenance:

- All seals and o-rings
- Diffuser screen
- Exhaust valve
- Internal afterfilter
- All filter elements
- Desiccant

Please contact Amico Source Corporation’s engineering department for parts needed and reference your call with the job number on the system.

## Changing the Desiccant

### Dryspell Plus 10, 20, 30

- Bypass the dryer.
- Disconnect the dryer from air lines.
- Loosen the tie rod and remove it.
- Remove the old adsorbent and fill activated alumina and molecular sieves.
- Make sure O-rings or gaskets are in place.
- Install and screw the tie rod.

### Dryspell Plus 45, 60

- Bypass the dryer.
- Disconnect dryer from air lines.
- Loosen the M8 Allen bolt and remove the top block and top compactor plate.
- Remove the saturated desiccant bag by pulling the bag handle in an upward direction and replace with the new desiccant bag. If there is no desiccant bag, just tilt the dryer to remove the old desiccant and replace with a new desiccant bag.
- Make sure O-rings or gaskets are in place.
- Install the top compactor plate, followed by the top block, then screw in the M8 Allen bolt.



# Maintenance

## Dryspell Plus 100, 200, 300

- Bypass the dryer.
- Disconnect dryer from air lines.
- Loosen the M8 Allen bolt and remove the top block and top compactor plate.
- Remove the saturated desiccant bag by pulling the bag handle in an upward direction and replace with the new desiccant bag. For replacement, put a no. 3 activated alumina bag and a no. 1 molecular sieves bag in each tower. If there is no desiccant bag, just tilt the dryer to remove the old desiccant and replace with a new desiccant bag.
- Make sure O-rings or gaskets are in place.
- Install the top compactor plate, followed by the top block, then screw in the M8 Allen bolt.

## Dryspell Plus 125, 250, 375

- Bypass the dryer.
- Disconnect dryer from air lines.
- Loosen the M8 Allen bolt and remove the top block and top compactor plate.
- Remove the saturated desiccant bag by pulling the bag handle in an upward direction and replace with the new desiccant bag. For replacement, put a no. 3 activated alumina bag and a no. 1 activated alumina and molecular sieves bag as well as a no. 1 molecular sieves bag (AD1424) in each tower. If there is no desiccant bag, just tilt the dryer to remove the old desiccant and replace with a new desiccant bag.
- Make sure O-rings or gaskets are in place
- Install the top compactor plate, followed by the top block, then screw in the M8 Allen bolt

## Dew Point Sensor Calibration

Amico Source Corporation recommends the Dew Point Sensor be calibrated annually due to sensor drift over time. For calibration, please contact Amico Source Corporation's technical support.

# Maintenance

## CO Transmitter Calibration

### Materials Needed:

- Voltmeter to read 40mV and 200mV
- Zero Gas
- 20 ppm gas
- Flow regulator
- Pipe connector (provided with the kit)

### Instructions:

1. Open the CO transmitter
2. Replace sensor if necessary
3. Connect zero gas to transmitter piping and allow it to flow at 0.5 lpm for two minutes or until the reading stabilizes
4. Connect the two probes on the voltmeter to the two test terminals
5. Adjust the zero potentiometer to 40 mV using a small flat-head screwdriver
6. Disconnect zero gas and connect 20 ppm gas and allow it to flow at 0.5 lpm for two minutes or until the reading stabilizes
7. Adjust the span potentiometer to 50.6 mV using a small flat-head screwdriver
8. Reconnect supply air to sensor

Please refer to the diagram on page 26.

# Control Panel Troubleshooting

To Begin troubleshooting the system, press the System Status button which reads "FAULT! CLICK HERE" or "SYSTEM FAULT!".

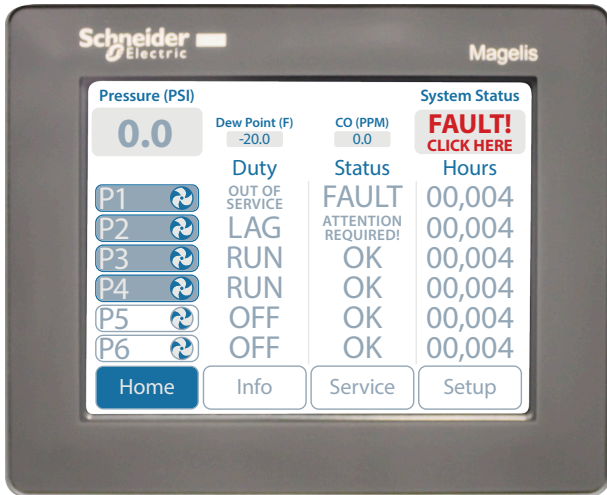

Pro IEC Display Screen

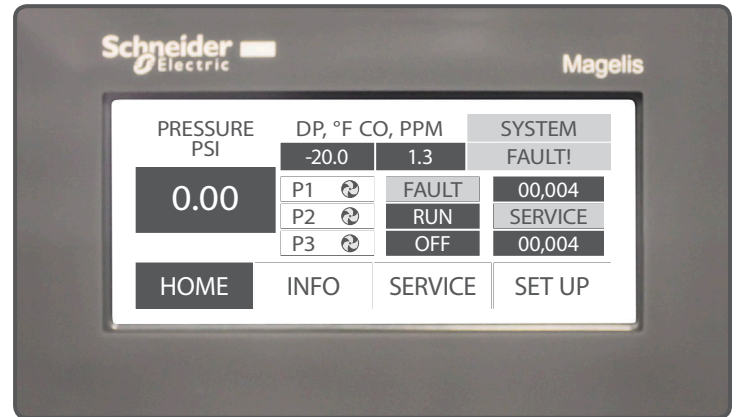

ECO+ Display Screen

You will get a screen like the one shown below:

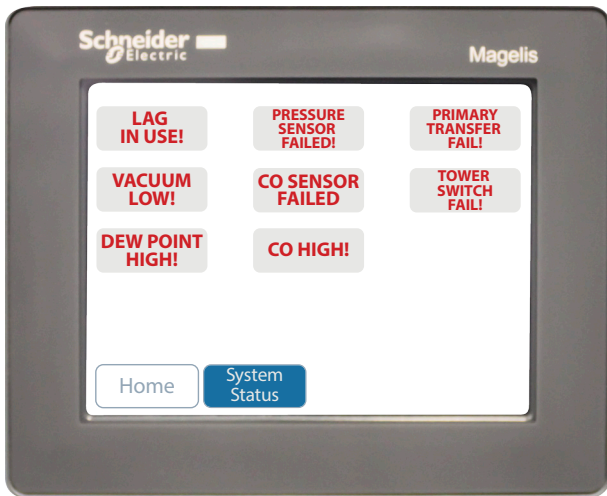

Pro IEC Display Screen

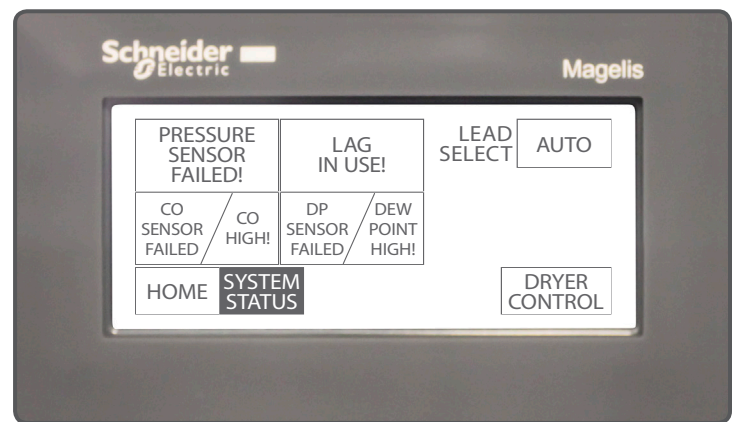

ECO+ Display Screen

# Control Panel Troubleshooting

Problem	Possible Causes	Solution
Pressure sensor failed	<ul style="list-style-type: none"> <li>Loose Wire</li> </ul>	<ul style="list-style-type: none"> <li>Check the wiring between the sensor and terminal in the panel</li> </ul>
"ERROR" in place of pressure readout	<ul style="list-style-type: none"> <li>Pressure sensor is faulty</li> </ul>	<ul style="list-style-type: none"> <li>Replace pressure sensor</li> </ul>
Lag in use	<ul style="list-style-type: none"> <li>Last available pump is called</li> <li>One of the pumps may be out of service</li> </ul>	<ul style="list-style-type: none"> <li>Confirm all pumps are working on automatic</li> <li>Once at least one of the pumps is turned off automatically in the system, press alarm reset</li> <li>Investigate the demand from the facility</li> </ul>
Primary transformer failed	<ul style="list-style-type: none"> <li>Transformer failure</li> <li>Burned out fuse</li> </ul>	<ul style="list-style-type: none"> <li>Contact certified technician</li> </ul>
DP sensor failed	<ul style="list-style-type: none"> <li>Loose wire</li> </ul>	<ul style="list-style-type: none"> <li>Check the wiring between the sensor and terminal in the panel</li> </ul>
"ERROR" in place of dew point readout	<ul style="list-style-type: none"> <li>Faulty Sensor</li> </ul>	<ul style="list-style-type: none"> <li>Replace dew point sensor</li> </ul>
DP sensor failed	<ul style="list-style-type: none"> <li>Loose wire</li> </ul>	<ul style="list-style-type: none"> <li>Check the wiring between the sensor and terminal in the panel</li> </ul>
"ERROR" in place of CO readout	<ul style="list-style-type: none"> <li>Faulty Sensor</li> </ul>	<ul style="list-style-type: none"> <li>Check connection to CO transmitter, replace if needed</li> </ul>
***	<ul style="list-style-type: none"> <li>Faulty sensor</li> </ul>	<ul style="list-style-type: none"> <li>Requires calibration or replacement</li> </ul>
Dew point high	<ul style="list-style-type: none"> <li>High dew point</li> </ul>	<ul style="list-style-type: none"> <li>Check the wiring between the sensor and terminal in the panel</li> </ul>
CO high alarm	<ul style="list-style-type: none"> <li>Air system only</li> <li>High CO level</li> <li>RF interference</li> </ul>	<ul style="list-style-type: none"> <li>Check the inlet of the air system for possible source of CO</li> <li>Call Amico Source Corporation's technical support to adjust setting of the CO readout</li> <li>Press "Alarm Reset" once CO level falls below the set alarm valve</li> </ul>
Tower switch fail alarm (Canadian system only)	<ul style="list-style-type: none"> <li>CSA air systems only</li> <li>Loose wire</li> <li>Dryer tower failed to switch during purge cycle</li> </ul>	<ul style="list-style-type: none"> <li>Please refer to dryer troubleshooting to determine the cause</li> <li>Check for loose wires in the control panel</li> <li>Press "Alarm Reset" once situation is resolved to clear the alarm</li> </ul>
Receiver high water (Québec systems only)	<ul style="list-style-type: none"> <li>CSA air systems in Québec only</li> <li>High water level in receiver tank</li> </ul>	<ul style="list-style-type: none"> <li>Check receiver tank for water</li> <li>Drain tank as necessary</li> <li>Replace sensor as necessary</li> </ul>

# Reciprocating Compressor Troubleshooting

Problem	Possible Causes	Solution
Failure to start	Main power disconnected	Turn on main power
	Phase reversal monitor open	Change power supply phase on incoming power
		Check voltage dial setting on phase reversal switch
	Power failure	Restore power
	Main fuse blown	Replace fuse
	Fuse blown in control circuit	Replace fuse
	Overload tripped on starter	Reset and check for system overload
	High temperature switch activated	Allow unit to cool, reset switch and check for over temperature condition
	Vacuum switch open	Adjust or replace switch
Loose or faulty connection	Check and tighten all wire connections	
Power failure	Main fuse blown	Replace fuse
	Fuse blown in control circuit	Replace fuse
Compressor shuts off unexpectedly	Overload tripped on starter	Reset and check for system overload
	Pressure switch has incorrect adjustment	Adjust or replace
	High inlet vacuum switch activated	Check for dirty/clogged inlet filter or inlet piping restriction
	High temperature switch activated	Allow unit to cool, reset switch and check for over temperature condition
High temperature alarm	High temperature switch activated	Allow unit to cool, reset switch and check for over temperature condition
Low discharge pressure	System piping leaks	Repair leaks
	Defective pressure gauge	Replace gauge
	Pressure switch open	Adjust or replace
	No power to solenoid or solenoid stuck open	Check electrical connections
	Belts slipping	Adjust tension
	Intake filter clogged	Clean or replace
Compressor cycles too often	System undersized	Contact Amico Source Corporation
	Incorrect pressure setting	Adjust pressure switch
	Faulty pressure switch	Replace switch
	System piping leaks	Repair leaks
	Check valve or the line to receiver is leaking or plugged	Replace if necessary
	Both dryers online	Close valve to one dryer
	Water in air receiver	Drain air receiver
Compressor won't shut off	Pressure switch has incorrect adjustment or it is faulty	Adjust or replace
Excessive belt wear	Belt tension	Adjust tension
	Belt alignment	Realign compressor and motor sheaves

# Reciprocating Compressor Troubleshooting

Problem	Possible Causes	Solution
Abnormal noise	Mounting bolts loose	Tighten bolts
	Belt tension	Adjust tension
Motor overheating	Low voltage	Check for proper supply voltage
	V-belt too tight	Adjust belt tension
	Defective motor	Contact Amico Source Corporation
Compressor runs hot	Incorrect pressure setting	Adjust pressure switch
	Faulty check valve	Contact Amico Source Corporation
	Check if valve or the line to receiver is leaking or plugged	Replace if necessary
	Intake filter clogged	Clean or replace

# Heatless Desiccant Dryer Troubleshooting

Problem	Possible Causes	Solution
Control Screen indicates a tower switch, but tower not switching	<ul style="list-style-type: none"> <li>Loose wire</li> <li>Stuck solenoid valve</li> </ul>	<ul style="list-style-type: none"> <li>Check coil connection at DIN and terminal connector in the panel</li> <li>Check the solenoid valve</li> </ul>
No purging	<ul style="list-style-type: none"> <li>Stuck solenoid valve</li> <li>Clogged exhaust valve</li> <li>Clogged silencer/ muffler</li> </ul>	<ul style="list-style-type: none"> <li>Check the solenoid valve</li> <li>Check the exhaust valve</li> <li>Clean the silencer (muffler)</li> </ul>
Continuous purging at tower 1	<ul style="list-style-type: none"> <li>Shuttle not closing</li> </ul>	<ul style="list-style-type: none"> <li>Check pilot air for exhaust valve</li> <li>Check exhaust valve piston stuck</li> </ul>
High purge loss	<ul style="list-style-type: none"> <li>Shuttle not closing</li> </ul>	<ul style="list-style-type: none"> <li>Check outlet shuttle closing</li> <li>Check for silencer choke</li> </ul>
High pressure drop across dryer	<ul style="list-style-type: none"> <li>Pre-filter may be clogged</li> </ul>	<ul style="list-style-type: none"> <li>Check and replace filter elements</li> </ul>

# Warranty Policy - Medical Air and Vacuum Systems

Amico Source Corporation warrants the equipment it manufactures to be free of defects in materials or workmanship when installed and operated in accordance with instructions. The Warranty Periods commence upon shipment or at start up, whichever period terminates earlier.

## Standard Warranty Periods

	From Shipment	From Start-up
Medical Air Systems	30 months	24 months
Desiccant Air Dryer Systems	30 months	24 months
Lubricated Vane Vacuum Systems	30 months	24 months
Oil-less Vane Vacuum Systems	30 months	24 months
Liquid Ring Vacuum Systems	30 months	24 months
Claw (Standard and O2 Assured) Vacuum Systems	30 months	24 months

## Conditions of Standard Warranty Periods – Complete Systems

30 months from the date of shipment or 24 months from start-up, whichever comes first, on replacement of defective parts. Labor, travel and shipping costs are covered for 18 months from the date of shipment or 12 months from start-up, whichever comes first.

## Conditions of Standard Warranty Periods – Parts Orders

12 months from the date of shipment on replacement of defective parts only.

This warranty covers all necessary parts and services as defined in the Conditions of Standard Warranty Periods, required for correction of the defect whether by any or all of repair, replacement, or credit, which election shall be made by Amico Source Corporation at its sole discretion, and which are purchaser's only remedies for breach of warranty.

This warranty requires the owner to ensure that the equipment is:

- Installed in accordance with installation and maintenance manuals provided with the product
- Started up or placed in service by an authorized representative of Amico Source Corporation, which includes the completion and forwarding to Amico Source Corporation of a Start-up and Warranty Registration Form; downloadable from the following location: <http://www.amico.com/warranties>
- Certified in accordance with all applicable local standards, by a properly qualified certification agency
- Maintained in strict accordance with Operation and Maintenance Instructions provided with the product

# Warranty Policy - Medical Air and Vacuum Systems

Warranty claims will be honoured only after defective parts are evaluated by Amico Source Corporation and only when the examination discloses to Amico Source Corporation's reasonable satisfaction that the equipment has not been damaged in shipment or improperly installed, operated outside of any published parameters (including but not limited to temperature, pressure, or ventilation), improperly or inadequately maintained, field modified in any way, improperly repaired, or in any other way improperly applied or used.

All claims against this warranty require prompt notification, within the warranty period, of any seeming defect. Failure to promptly notify Amico Source Corporation of the seeming defect will invalidate all warranties.

Amico Source Corporation is not liable for delay, damage or defect caused by shipping, acts of God, fire, war, labor difficulties, action of government, or other cause beyond the reasonable control of Amico Source Corporation. If there is a material delay in delivery for any reason, purchaser's only remedy is to cancel the purchase order.

**This warranty is given in lieu of all other warranties, expressed or implied, including implied warranties of fitness for a particular purpose and merchantability. In no event is Amico Source Corporation liable for damages in excess of the value of the defective product, nor is Amico Source Corporation liable for any indirect, special or consequential damages, loss of profit of any kind, or for loss of use of the products, even if Amico Source Corporation is aware or should be aware of the possibility of the same.**

## Replacement Parts

### **Amico Source Corporation**

85 Fulton Way

Richmond Hill, Ontario

L4B 2N4

Phone: (877) 462-6426

Fax: (866) 440-4986

For parts: [as-parts@amico.com](mailto:as-parts@amico.com)



# Maintenance Record

**Model Number:** \_\_\_\_\_

**Serial Number:** \_\_\_\_\_

**Installation Date:** \_\_\_\_\_

Date of Service								
Hours								
Load								
Ambient Temperature								
Inlet Filter								
Belts and Belt Tension								
Dryer Filters								
Desiccant and Valves								
CO Sensor								
DP Sensor								
Misc.								
Serviced By								

# www.amico.com

Amico Source Corporation | [www.amico.com](http://www.amico.com)

85 Fulton Way, Richmond Hill  
Ontario, L4B 2N4, Canada

600 Prime Place, Hauppauge  
NY 11788, USA

Toll Free Tel: 1.877.462.6426  
Toll Free Fax: 1.866.440.4986  
Tel: 905.764.0800  
Fax: 905.764.0862  
Email: [info@amico.com](mailto:info@amico.com)